

DESCRIPTION

The CNY17 series consists of a Gallium Arsenide IRED coupled with an NPN phototransistor.

CNY17-1	CNY17-3
CNY17-2	CNY17-4

FEATURES

- CNY17-1/2/3 are also available in white package by specifying -M suffix (eg. CNY17-2-M)
- UL recognized (File # E90700)
- VDE recognized
 - 102497 for white package -Add option V for white package (e.g., CNY17-2V-M)
 - File #102497 -Add option '300' for black package (e.g., CNY17-2.300)
 - File #94766
- Current transfer ratio in select groups
- High BV_{CEO} —70V minimum

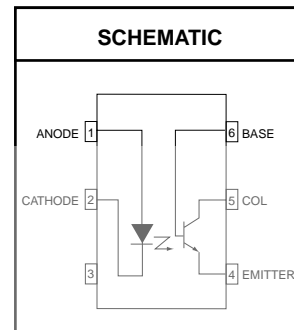

APPLICATIONS

- Power supply regulators
- Microprocessor inputs
- Industrial controls
- Digital logic inputs
- Appliance sensor systems

WHITE PACKAGE (-M SUFFIX)

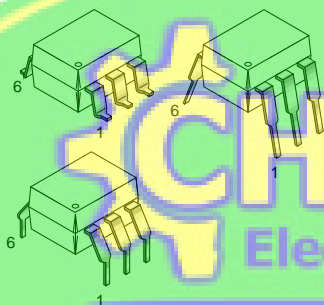

BLACK PACKAGE (NO -M SUFFIX)

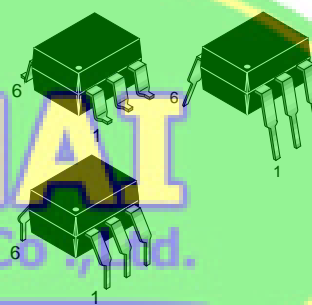

Parameters	Symbol	Device	Value	Units
TOTAL DEVICE				
Storage Temperature	T_{STG}	All	-55 to +150	°C
Operating Temperature	T_{OPR}	All	-55 to +100	°C
Lead Solder Temperature	T_{SOL}	All	260 for 10 sec	°C
Total Device Power Dissipation @ 25°C (LED plus detector)	P_D	-M	250	mW
Derate Linearly From 25°C		non -M	260	
		-M	2.94	mW/°C
		non -M	3.50	
EMITTER				
Continuous Forward Current	I_F	-M	60	mA
Reverse Voltage	V_R	All	6	
Forward Current - Peak (1 μ s pulse, 300 pps)	$I_{F(pk)}$	-M	1.5	A
LED Power Dissipation 25°C Ambient	P_D	non -M	3.0	
Derate Linearly From 25°C		-M	120	mW
		non -M	135	
		-M	1.41	mW/°C
	non -M	1.8		
DETECTOR				
Detector Power Dissipation @ 25°C	P_D	-M	150	mW
Derate Linearly from 25°C		non -M	200	
		-M	1.76	mW/°C
		non -M	2.67	

CNY17-1 CNY17-3
CNY17-2 CNY17-4

ELECTRICAL CHARACTERISTICS ($T_A = 25^\circ\text{C}$ Unless otherwise specified.)

INDIVIDUAL COMPONENT CHARACTERISTICS

Parameters	Test Conditions	Symbol	Device	Min	Typ	Max	Units
EMITTER Input Forward Voltage	$I_F = 60 \text{ mA}$	V_F	-M		1.35	1.65	V
	$I_F = 10 \text{ mA}$		non -M		1.15	1.50	
Capacitance	$V_F = 0 \text{ V}, f = 1.0 \text{ MHz}$	C_J	non -M		50		pF
			-M		18		
Reverse Leakage Current	$V_R = 6 \text{ V}$	I_R	All		0.001	10	μA
DETECTOR							
Breakdown Voltage Collector to Emitter	$I_C = 1.0 \text{ mA}, I_F = 0$	BV_{CEO}	All	70	100		V
Collector to Base	$I_C = 10 \mu\text{A}, I_F = 0$	BV_{CBO}	All	70	120		V
Emitter to Collector	$I_E = 100 \mu\text{A}, I_F = 0$	BV_{ECO}	All	7	10		V
Leakage Current Collector to Emitter	$V_{CE} = 10 \text{ V}, I_F = 0$	I_{CEO}	All		1	50	nA
Collector to Base	$V_{CB} = 10 \text{ V}, I_F = 0$	I_{CBO}	All			20	nA
Capacitance Collector to Emitter	$V_{CE} = 0, f = 1 \text{ MHz}$	C_{CE}	All		8		pF
Collector to Base	$V_{CB} = 0, f = 1 \text{ MHz}$	C_{CB}	All		20		pF
Emitter to Base	$V_{EB} = 0, f = 1 \text{ MHz}$	C_{EB}	All		10		pF

ISOLATION CHARACTERISTICS

Characteristic	Test Conditions	Symbol	Device	Min	Typ**	Max	Units
Input-Output Isolation Voltage	$f = 60 \text{ Hz}, t = 1 \text{ min.}$	V_{ISO}	Black Package	5300			Vac(rms)*
			'-M' White Package	7500			Vac(pk)
Isolation Resistance	$V_{I-O} = 500 \text{ VDC}$	R_{ISO}	All	10^{11}			Ω
Isolation Capacitance	$V_{I-O} = \emptyset, f = 1 \text{ MHz}$	C_{ISO}	Black Package		0.5		pF
			'-M' White Package		0.2		

Note

* 5300 Vac(rms) for 1 minute equates to approximately 9000 Vac (pk) for 1 second

** Typical values at $T_A = 25^\circ\text{C}$

CNY17-1 CNY17-3
CNY17-2 CNY17-4

TRANSFER CHARACTERISTICS ($T_A = 25^\circ\text{C}$ Unless otherwise specified.)							
DC Characteristics	Test Conditions	Symbol	Device	Min	Typ	Max	Units
Current Transfer Ratio, Collector to Emitter	$I_F = 10\text{ mA}, V_{CE} = 5\text{ V}$	CTR	CNY17-1/-1-M	40		80	%
			CNY17-2/-2-M	63		125	
			CNY17-3/-3-M	100		200	
			CNY17-4	160		320	
Saturation Voltage	$I_F = 10\text{ mA}, I_C = 2.5\text{ mA}$	$V_{CE(SAT)}$	All			.40	V
AC Characteristics	Test Conditions	Symbol	Device	Min	Typ	Max	Units
Non-Saturated Switching Times							
Turn-On Time (Fig.19 and Fig.20)	$R_L = 100\ \Omega, I_C = 2\text{ mA}, V_{CC} = 10\text{ V}$	t_{on}	non -M			10	μs
Turn-Off Time (Fig.19 and Fig.20)	$R_L = 100\ \Omega, I_C = 2\text{ mA}, V_{CC} = 10\text{ V}$	t_{off}	non -M			10	μs
Delay Time (Fig.19 and Fig.20)	$I_F = 10\text{ mA}, V_{CC} = 5\text{ V}, R_L = 75\ \Omega$	t_d	-M			5.6	μs
Rise Time (Fig.19 and Fig.20)	$I_F = 10\text{ mA}, V_{CC} = 5\text{ V}, R_L = 75\ \Omega$	t_r	-M			4.0	μs
Storage Time (Fig.19 and Fig.20)	$I_F = 10\text{ mA}, V_{CC} = 5\text{ V}, R_L = 75\ \Omega$	t_s	-M			4.1	μs
Fall Time (Fig.19 and Fig.20)	$I_F = 10\text{ mA}, V_{CC} = 5\text{ V}, R_L = 75\ \Omega$	t_f	-M			3.5	μs
Saturated Switching Times	$I_F = 20\text{ mA}, V_{CE} = 0.4\text{ V}$		CNY17-1			5.5	
Turn-On Time (Fig.19 and Fig.20)	$I_F = 10\text{ mA}, V_{CE} = 0.4\text{ V}$	t_{on}	CNY17-2, CNY17-3, CNY17-4			8.0	μs
	$I_F = 20\text{ mA}, V_{CE} = 0.4\text{ V}$		CNY17-1			4.0	
Rise-Time (Fig.19 and Fig.20)	$I_F = 10\text{ mA}, V_{CE} = 0.4\text{ V}$	t_r	CNY17-2, CNY17-3, CNY17-4			6.0	μs
	$I_F = 20\text{ mA}, V_{CC} = 5\text{ V}, R_L = 1\text{ K}\Omega$		CNY17-1-M			4.0	
	$I_F = 10\text{ mA}, V_{CC} = 5\text{ V}, R_L = 1\text{ K}\Omega$		CNY17-2-M, CNY17-3-M			6.0	
	$I_F = 20\text{ mA}, V_{CC} = 5\text{ V}, R_L = 1\text{ K}\Omega$		CNY17-1-M			5.5	
Delay Time (Fig.19 and Fig.20)	$I_F = 10\text{ mA}, V_{CC} = 5\text{ V}, R_L = 1\text{ K}\Omega$	t_d	CNY17-2, CNY17-3			8.0	μs
	$I_F = 20\text{ mA}, V_{CC} = 5\text{ V}, R_L = 1\text{ K}\Omega$		CNY17-1-M			5.5	
Turn-Off Time (Fig.19 and Fig.20)	$I_F = 20\text{ mA}, V_{CE} = 0.4\text{ V}$	t_{off}	CNY17-1			34.0	μs
	$I_F = 10\text{ mA}, V_{CE} = 0.4\text{ V}$		CNY17-2, CNY17-3, CNY17-4			39.0	
Fall-Time (Fig.19 and Fig.20)	$I_F = 20\text{ mA}, V_{CE} = 0.4\text{ V}$	t_f	CNY17-1			20.0	μs
	$I_F = 10\text{ mA}, V_{CE} = 0.4\text{ V}$		CNY17-2, CNY17-3, CNY17-4			24.0	
	$I_F = 20\text{ mA}, V_{CC} = 5\text{ V}, R_L = 1\text{ K}\Omega$		CNY17-1-M			20.0	
	$I_F = 10\text{ mA}, V_{CC} = 5\text{ V}, R_L = 1\text{ K}\Omega$		CNY17-2-M, CNY17-3-M			24.0	
Storage Time (Fig.19 and Fig.20)	$I_F = 20\text{ mA}, V_{CC} = 5\text{ V}, R_L = 1\text{ K}\Omega$	t_s	CNY17-1-M			34.0	μs
	$I_F = 10\text{ mA}, V_{CC} = 5\text{ V}, R_L = 1\text{ K}\Omega$		CNY17-2-M, CNY17-3-M			39.0	

CNY17-1 CNY17-3
CNY17-2 CNY17-4

Fig.1 Normalized CTR vs. Forward Current (Black Package)

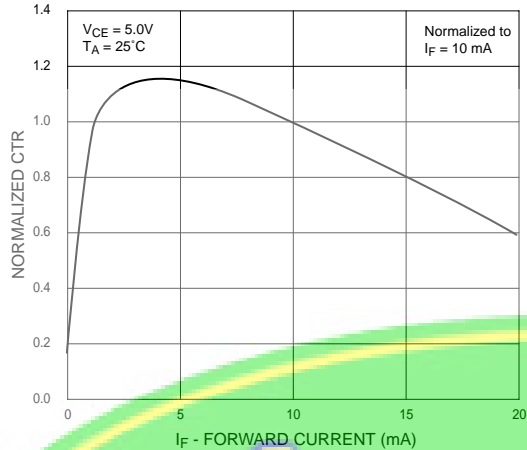

Fig.2 Normalized CTR vs. Forward Current (White Package)

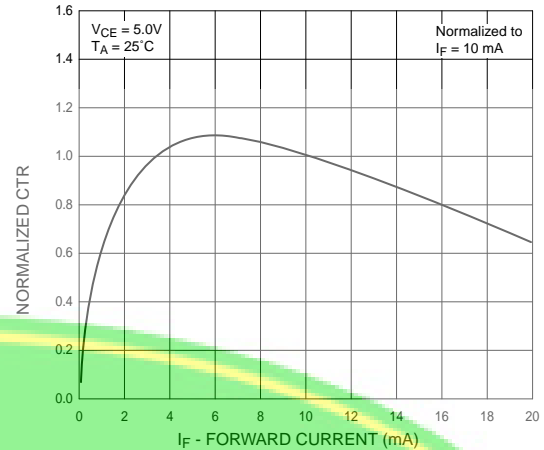

Fig. 3 Normalized CTR vs. Ambient Temperature (Black Package)

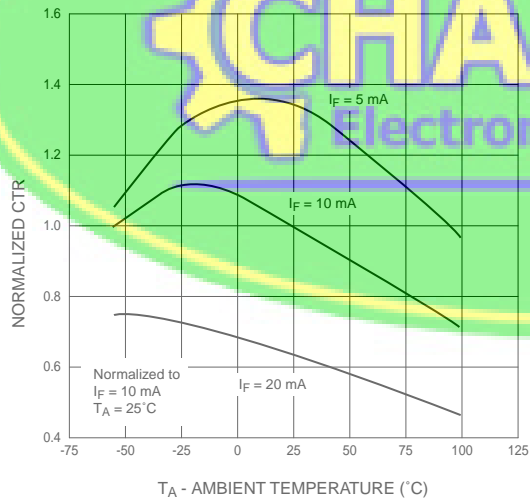

Fig. 4 Normalized CTR vs. Ambient Temperature (White Package)

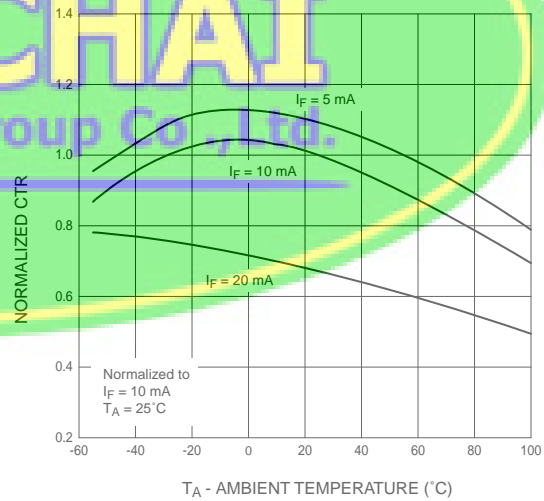

Fig. 5 CTR vs. RBE (Unsatrated) (Black Package)

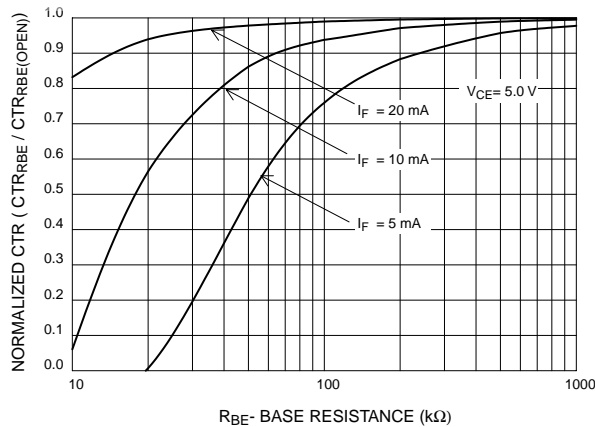
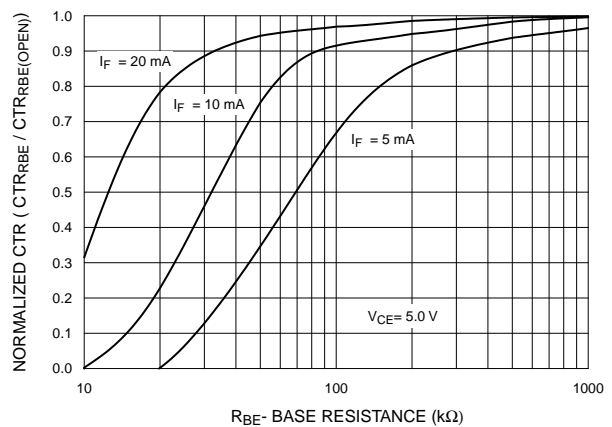

Fig. 6 CTR vs. RBE (Unsatrated) (White Package)



CNY17-1	CNY17-3
CNY17-2	CNY17-4

Fig. 7 CTR vs. RBE (Saturated)
(Black Package)

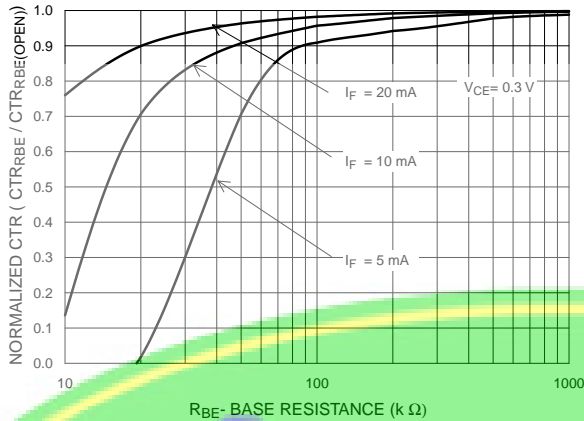

Fig. 8 CTR vs. RBE (Saturated)
(White Package)

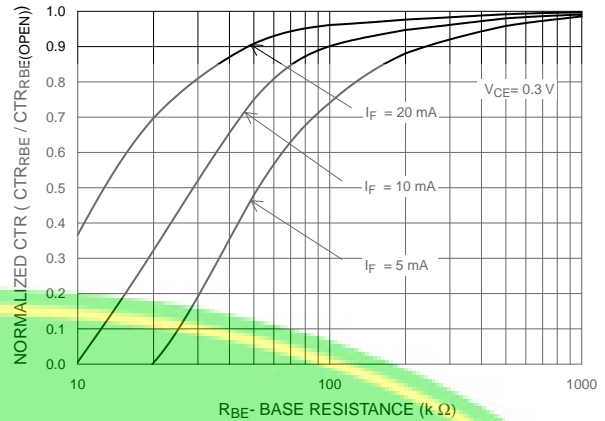

Fig. 9 Switching Speed vs. Load Resistor
(Black Package)

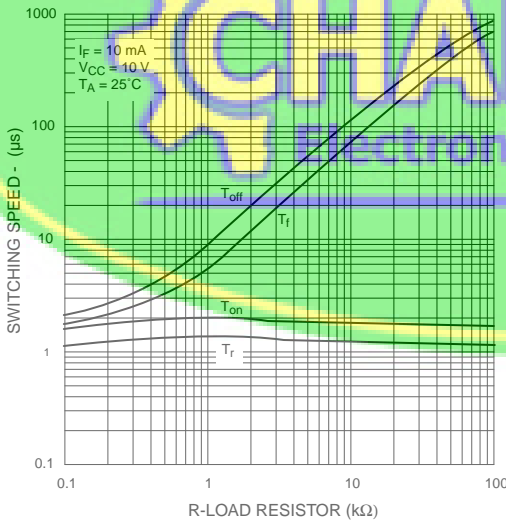

Fig. 10 Switching Speed vs. Load Resistor
(White Package)

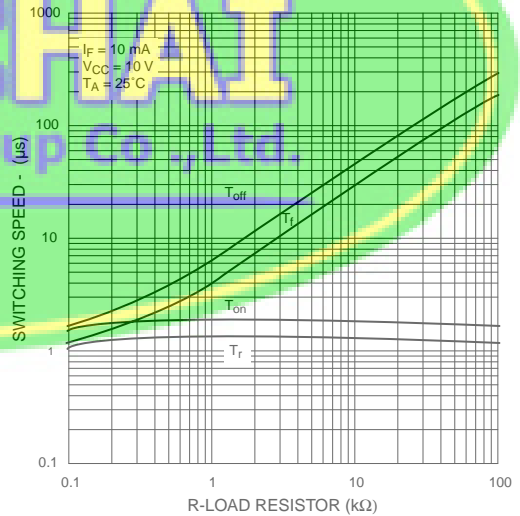

Fig. 11 Normalized ton vs. RBE
(Black Package)

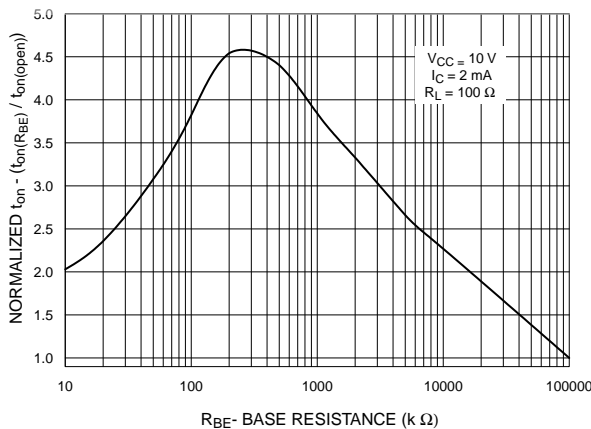
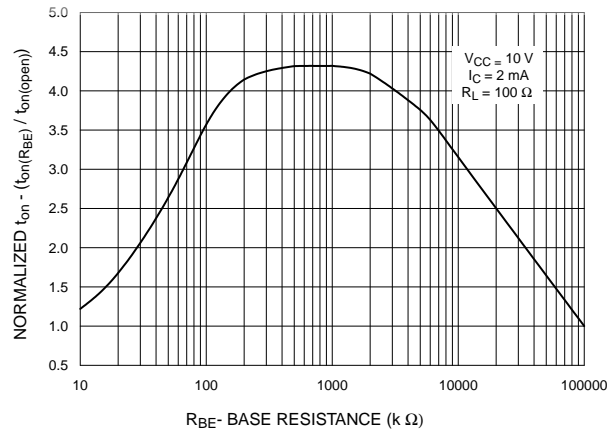

Fig. 12 Normalized ton vs. RBE
(White Package)



CNY17-1 CNY17-3
CNY17-2 CNY17-4

Fig. 13 Normalized t_{off} vs. R_{BE} (Black Package)

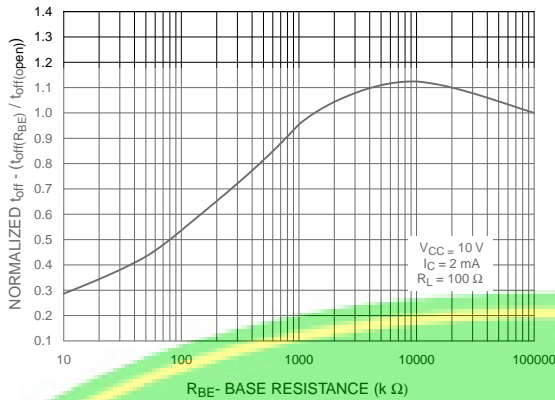

Fig. 14 Normalized t_{off} vs. R_{BE} (White Package)

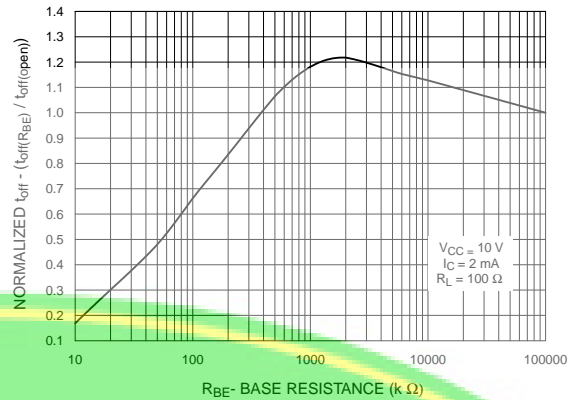

Fig. 15 LED Forward Voltage vs. Forward Current (Black Package)

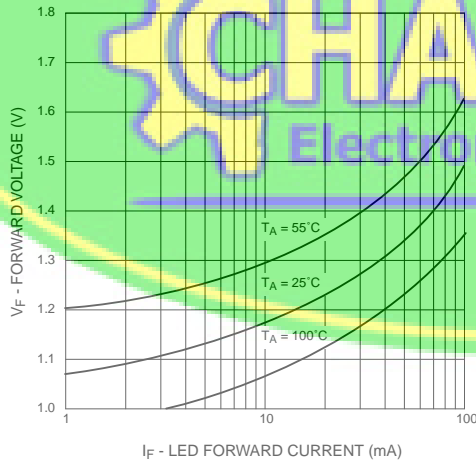

Fig. 16 LED Forward Voltage vs. Forward Current (White Package)

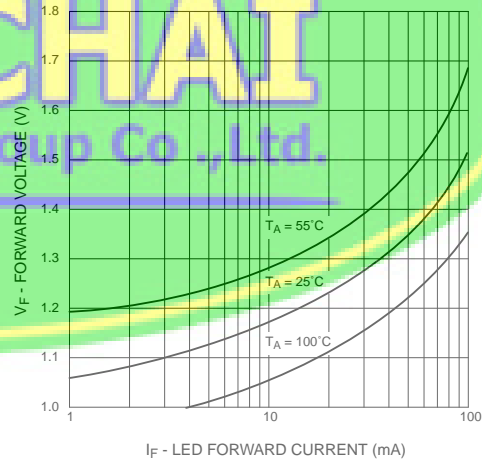

Fig. 17 Collector Current vs. Collector-Emitter Saturation Voltage

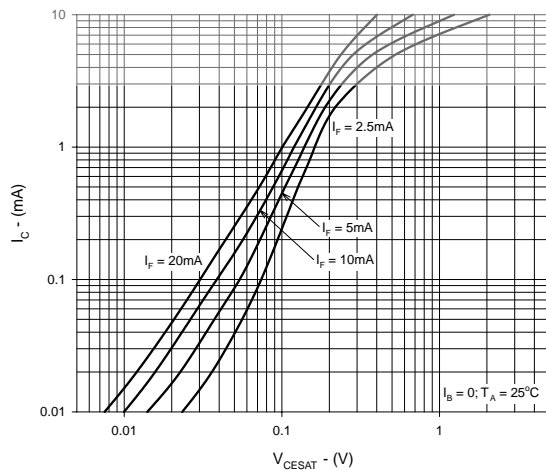
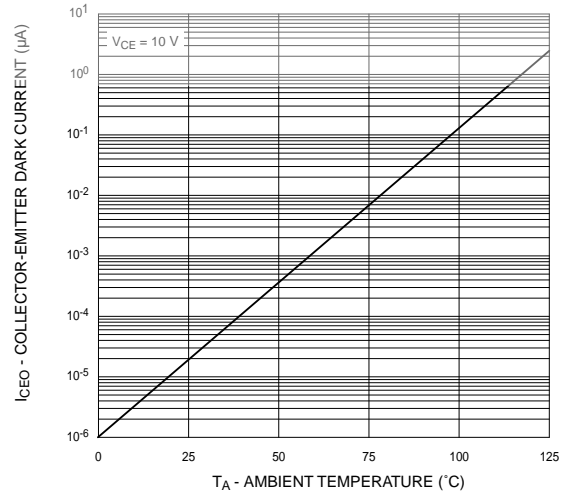

Fig. 18 Dark Current vs. Ambient Temperature (Black Package)



CNY17-1	CNY17-3
CNY17-2	CNY17-4

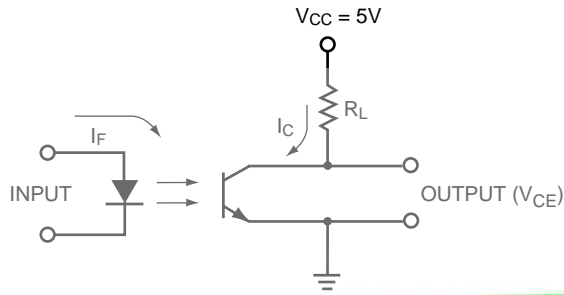

Figure 19. Switching Time Test Circuit

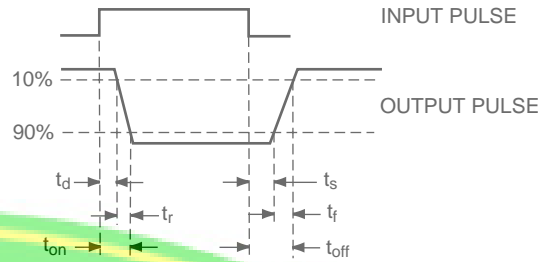

Figure 20. Switching Time Waveforms



Black Package (No -M Suffix)

CNY17-1	CNY17-3
CNY17-2	CNY17-4

Package Dimensions (Through Hole)

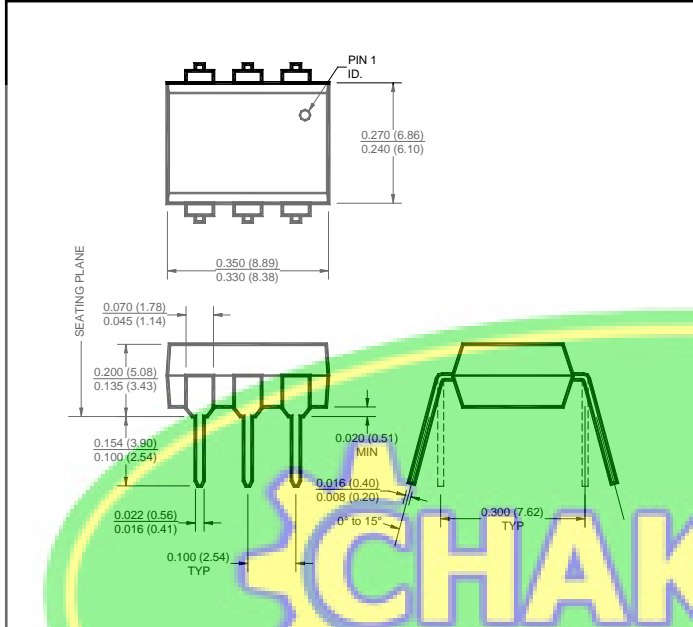

Package Dimensions (Surface Mount)

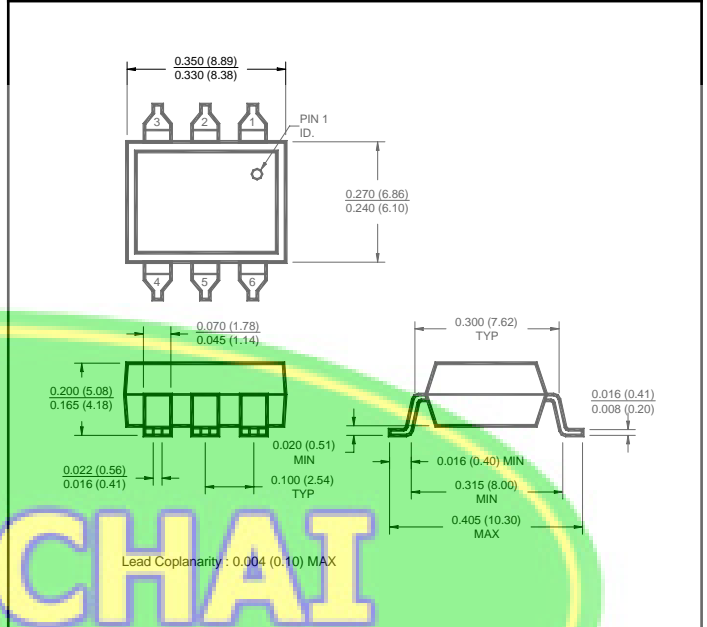

Package Dimensions (0.4" Lead Spacing)

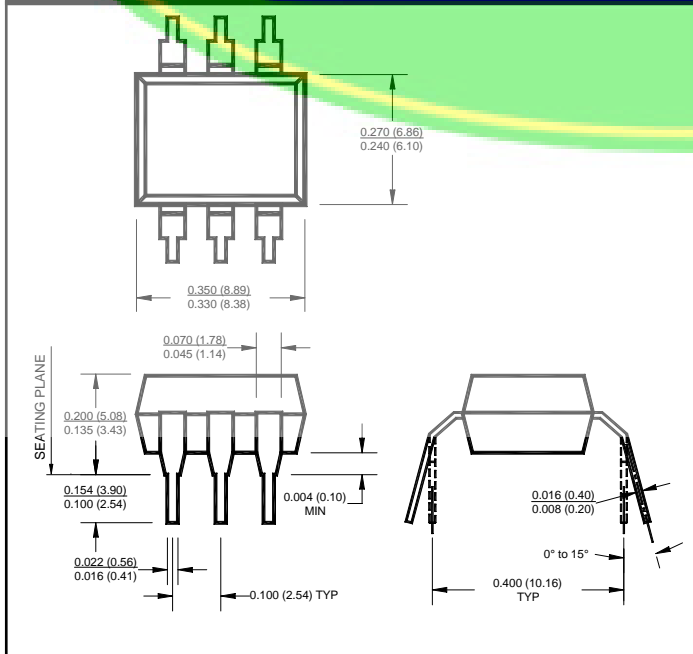

Recommended Pad Layout for Surface Mount Leadform (Black Package Only)

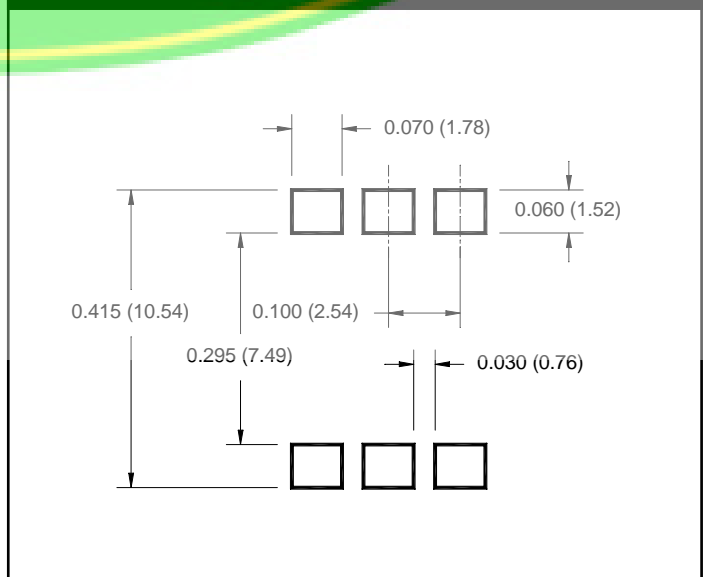

NOTE

All dimensions are in inches (millimeters)

White Package (-M Suffix)

CNY17-1	CNY17-3
CNY17-2	CNY17-4

Package Dimensions (Through Hole)

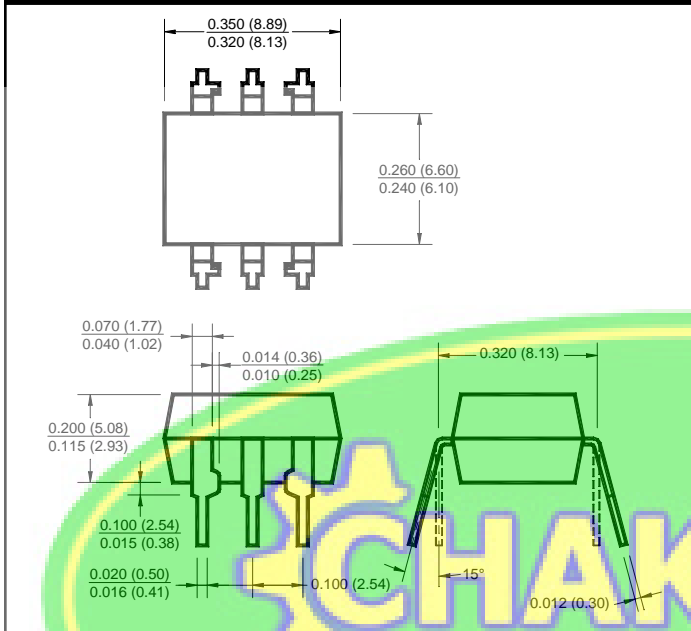

Package Dimensions (Surface Mount)

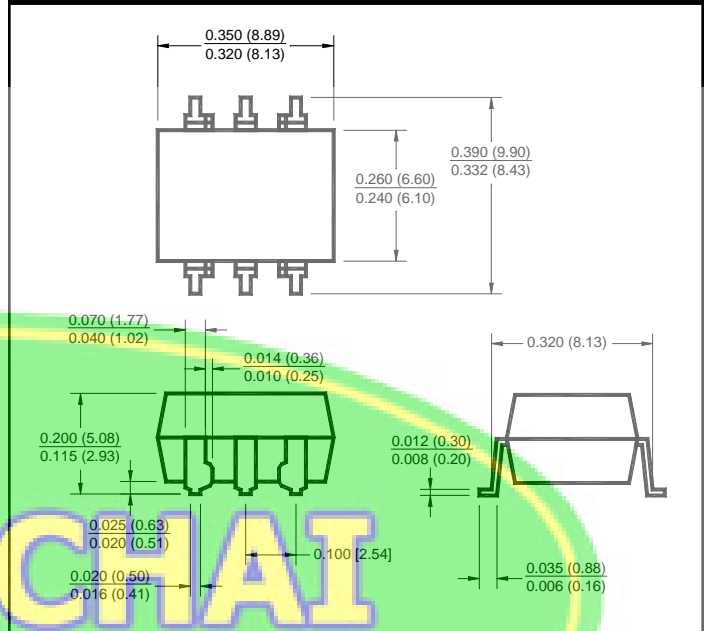

Package Dimensions (0.4" Lead Spacing)

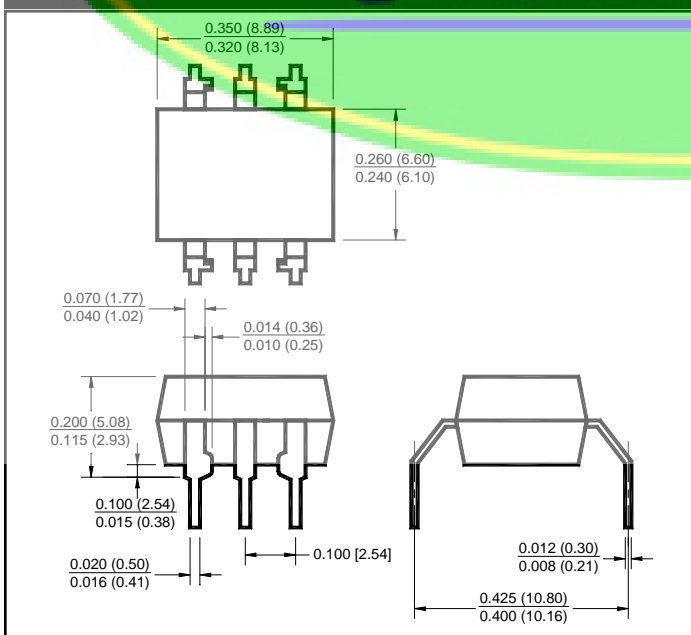

Recommended Pad Layout for Surface Mount Leadform (White Package Only)

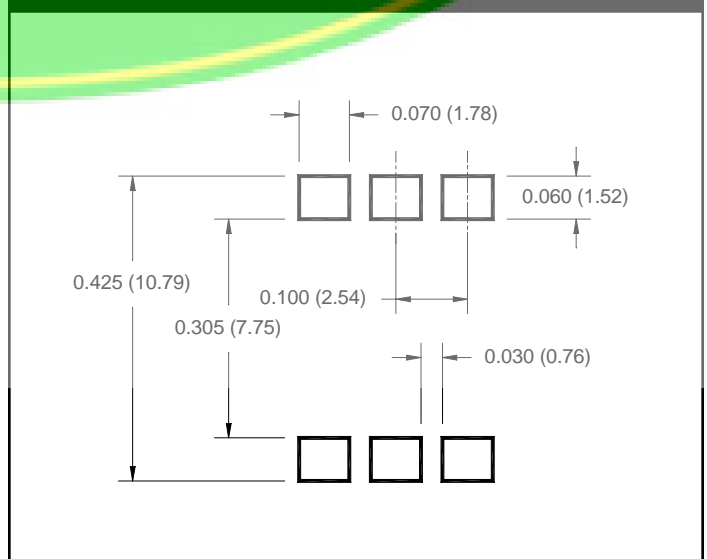

NOTE

All dimensions are in inches (millimeters)

CNY17-1	CNY17-3
CNY17-2	CNY17-4

ORDERING INFORMATION

Option	Black Package (No Suffix)	White Package (-m Suffix)	Description
Order Entry Identifier			
S	.S	S	Surface Mount Lead Bend
SD	.SD	SR2	Surface Mount; Tape and reel
W	.W	T	0.4" Lead Spacing
300	.300	V	VDE 0884
300W	.300W	TV	VDE 0884, 0.4" Lead Spacing
3S	.3S	SV	VDE 0884, Surface Mount
3SD	.3SD	SR2V	VDE 0884, Surface Mount, Tape & Reel

Carrier Tape Specifications (Black Package, No Suffix)

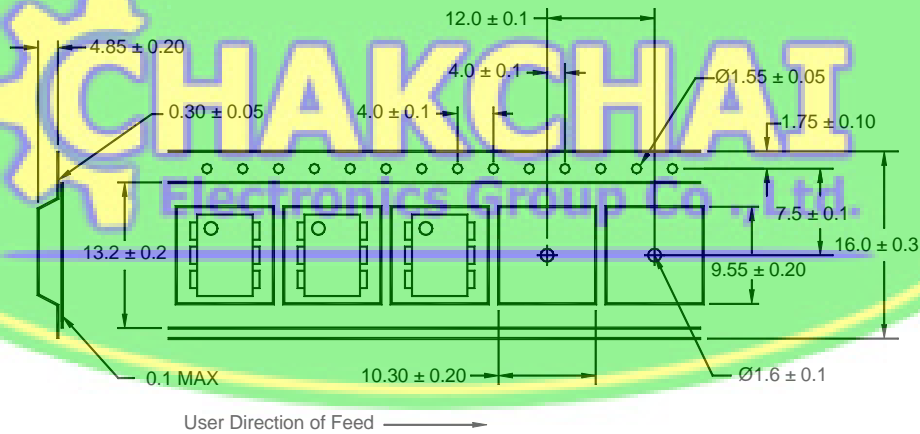

Carrier Tape Specifications (White Package, -M Suffix)

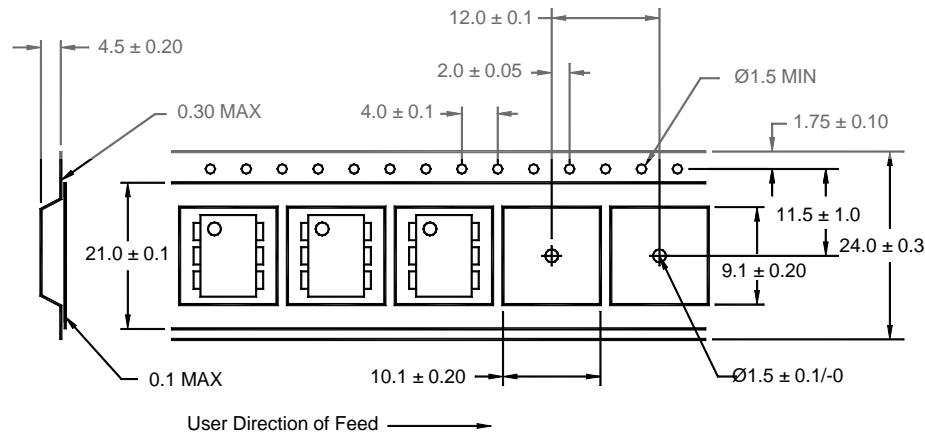

NOTE

All dimensions are in inches (millimeters)

CNY17-1	CNY17-3
CNY17-2	CNY17-4

DISCLAIMER

FAIRCHILD SEMICONDUCTOR RESERVES THE THE RIGHT TO MAKE CHANGES WITHOUT FURTHER NOTICE TO ANY PRODUCTS HEREIN TO IMPROVE RELIABILITY, FUNCTION OR DESIGN. FAIRCHILD DOES NOT ASSUME ANY LIABILITY ARISING OUT OF THE APPLICATION OR USE OF ANY PRODUCT OR CIRCUIT DESCRIBED HEREIN; NEITHER DOES IT CONVEY ANY LICENSE UNDER ITS PATENT RIGHTS, NOR THE RIGHTS OF OTHERS.

LIFE SUPPORT POLICY

FAIRCHILD'S PRODUCTS ARE NOT AUTHORIZED FOR USE AS CRITICAL COMPONENTS IN LIFE SUPPORT DEVICES OR SYSTEMS WITHOUT THE EXPRESS WRITTEN APPROVAL OF THE PRESIDENT OF FAIRCHILD SEMICONDUCTOR CORPORATION. As used herein:

1. Life support devices or systems are devices or systems which, (a) are intended for surgical implant into the body, or (b) support or sustain life, and (c) whose failure to perform when properly used in accordance with instructions for use provided in labeling, can be reasonably expected to result in a significant injury of the user.
2. A critical component in any component of a life support device or system whose failure to perform can be reasonably expected to cause the failure of the life support device or system, or to affect its safety or effectiveness.

