

19-4143; Rev. 0; 2/92

EVALUATION KIT
AVAILABLE



+5V and Adjustable Step-Down Current-Mode PWM Regulators

T-58-11-31

General Description

The MAX730/MAX738 are +5V-output CMOS, step-down, switching DC-DC regulators. The MAX750/MAX758 are adjustable output versions of the MAX730/MAX738. The MAX738 accepts inputs from 6.0V to 16.0V and delivers up to 750mA at 5V. The MAX730 accepts inputs from 5.2V to 11.0V and delivers up to 300mA at 5V. The MAX758 delivers up to 3.75W from inputs of 4.0V to 16.0V. The MAX750 delivers up to 1.5W from 4.0V to 11.0V inputs. Typical efficiencies exceed 90%, and accuracy is guaranteed over temperature, line, and load variations. Pulse-width modulation (PWM) current-mode control provides precise output regulation and low subharmonic noise. Typical quiescent current is 1.7mA. 165kHz switching frequency allows easy ripple and noise filtering and use of small external components. These regulators require only a single inductor value to function over their entire input range, so no inductor design is necessary.

The MAX730/738/750/758 also feature cycle-by-cycle current limiting, overcurrent limiting, undervoltage lockout, and programmable soft-start protection.

For lower-power step-down applications, refer to the MAX639 data sheet.

Applications

- Portable Instruments
- Distributed Power Systems
- Computer Peripherals
- DC-DC Converter Module Replacements

Typical Operating Circuit

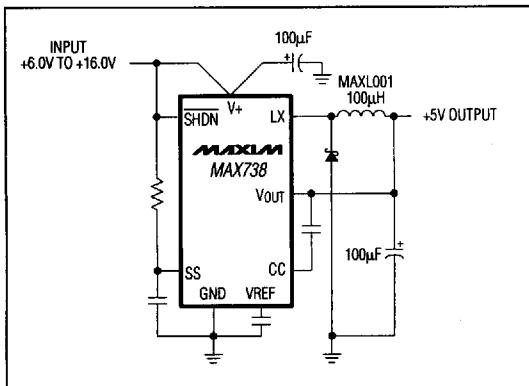

Features

- ◆ Up to 750mA Load Currents with No External MOSFETs (MAX738/MAX758)
- ◆ 165kHz High Frequency Current-Mode PWM
- ◆ Greater than 90% Typ Efficiencies
- ◆ Single Pre-Selected Inductor Value, No Component Design Required
- ◆ 1.7mA Typ Quiescent Current
- ◆ Overcurrent, Soft-Start, and Shutdown Protection
- ◆ Adjustable Output (MAX750/MAX758)
- ◆ 8-Pin DIP/SO and 16-Pin Wide SO Packages

Ordering Information

PART	TEMP. RANGE	PIN-PACKAGE
MAX730CPA	0°C to +70°C	8 Plastic DIP
MAX730CSA	0°C to +70°C	8 SO
MAX730C/D	0°C to +70°C	Dice*
MAX730EPA	-40°C to +85°C	8 Plastic DIP
MAX730ESA	-40°C to +85°C	8 SO
MAX730MJA	-55°C to +125°C	8 CERDIP**
MAX738CPA	0°C to +70°C	8 Plastic DIP
MAX738CWE	0°C to +70°C	16 Wide SO
MAX738C/D	0°C to +70°C	Dice*
MAX738EPA	-40°C to +85°C	8 Plastic DIP
MAX738EWE	-40°C to +85°C	16 Wide SO
MAX738MJA	-55°C to +125°C	8 CERDIP**

Ordering Information continued on last page.

* Contact factory for dice specifications.

** Contact factory for availability and processing to MIL-STD-883.

Pin Configurations

TOP VIEW

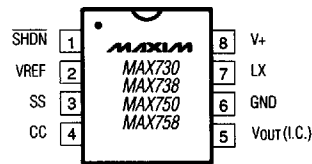

DIP

NOTE: () ARE FOR MAX750/MAX758 ONLY.

Pin Configurations continued on last page.

MAX730/738/750/758

4



Call toll free 1-800-998-8800 for free samples or literature.

+5V and Adjustable Step-Down Current-Mode PWM Regulators

MAX730/738/750/758

ABSOLUTE MAXIMUM RATINGS

Pin Voltages:

V+ (MAX730/750)	+12V, -0.3V
V+ (MAX738/758)	+18V, -0.3V
LX (MAX730/750)	(V+ -12V) to (V+ +0.3V)
LX (MAX738/758)	(V+ -21V) to (V+ +0.3V)
VOUT	±25V
SS, CC, SHDN	-0.3V to (V+ +0.3V)
Peak Switch Current (ILx)	2.0A
Reference Current (IvREF)	2.5mA
Power Dissipation (TA = +70°C)	
8-Pin Plastic DIP (derate 6.90mW/°C above +70°C)	552mW
8-Pin SO (derate 5.88mW/°C above +70°C)	471mW

16-Pin Wide SO (derate 9.52mW/°C above +70°C)	762mW
8-Pin CERDIP (derate 8.00mW/°C above +70°C)	640mW
Operating Temperature Ranges:	
MAX7__C	0°C to +70°C
MAX7__E	-40°C to +85°C
MAX7__MJA	-55°C to +125°C
Junction Temperatures:	
MAX7__C/E	+150°C
MAX7__M	+175°C
Storage Temperature Range	-65°C to +160°C
Lead Temperature (soldering, 10 sec)	+300°C

Stresses beyond those listed under "Absolute Maximum Ratings" may cause permanent damage to the device. These are stress ratings only, and functional operation of the device at these or any other conditions beyond those indicated in the operational sections of the specifications is not implied. Exposure to absolute maximum rating conditions for extended periods may affect device reliability.

ELECTRICAL CHARACTERISTICS

(Circuit of Figure 3; V+ = 9V for the MAX730/750; V+ = 12V for the MAX738/758; VOUT = 5V, R2 = 40.20kΩ, R3 = 13.0kΩ for the MAX750/758; ILOAD = 0mA; TA = TMIN to TMAX, unless otherwise noted.)

PARAMETER	CONDITIONS	MAX730/MAX750			MAX738/MAX758			UNITS
		MIN	TYP	MAX	MIN	TYP	MAX	
Output Voltage (Note 1)	V+ = 6.0V to 11.0V, 0 < ILOAD < 300mA	4.75	5.00	5.25				V
	V+ = 6.6V to 16.0V, 0 < ILOAD < 300mA				4.75	5.00	5.25	
	V+ = 10.2V to 16.0V, 0 < ILOAD < 750mA				4.75	5.00	5.25	
Input Voltage Range	MAX730 only	5.2		11.0				V
	MAX738 only				6.0		16.0	
	MAX750 only	4.0		11.0				
	MAX758 only				4.0		16.0	
Line Regulation	V+ = 5.2V to 11.0V		0.15					%V
	V+ = 6.0V to 16.0V					0.15		
Load Regulation	ILOAD = 0mA to 300mA		0.0005					%mA
	ILOAD = 0mA to 750mA					0.0005		
Efficiency	V+ = 9.0V, ILOAD = 300mA		92			90		%
	V+ = 12V, ILOAD = 750mA					87		
Supply Current	Includes switch current		1.7	3.0		1.7	3.0	mA
Standby Current	SHDN = 0 (Note 2)		6.0	100.0		6.0	100.0	μA
Shutdown Input Threshold	VIH (Note 3)	V+ - 0.5V			V+ - 0.5V			V
	VIL (Note 3)			0.25			0.25	
Shutdown Input Leakage Current				1.0			1.0	μA
Short-Circuit Current			1.5			1.5		A
Undervoltage Lockout	MAX730 only		4.7	5.2				V
	MAX738 only				5.7	6.0		
	MAX750 only		3.75	4.00				
	MAX758 only				3.75	4.00		

T-58-11-31

+5V and Adjustable Step-Down Current-Mode PWM Regulators

MAX730/738/750/758

ELECTRICAL CHARACTERISTICS (continued)

(Circuit of Figure 3; $V_+ = 9V$ for the MAX730/750; $V_+ = 12V$ for the MAX738/758; $V_{OUT} = 5V$, $R_2 = 40.20k\Omega$, $R_3 = 13.0k\Omega$ for the MAX750/758; $I_{LOAD} = 0mA$; $T_A = T_{MIN}$ to T_{MAX} , unless otherwise noted.)

PARAMETER	CONDITIONS	MAX730/750			MAX738/758			UNITS
		MIN	TYP	MAX	MIN	TYP	MAX	
LX On Resistance	$I_{LX} = 500mA$		0.5			0.5		Ω
LX Leakage Current	$V_+ = 12V$, $I_{LX} = 0$		1.0			1.0		μA
Reference Voltage (Note 1)		1.15	1.23	1.30	1.15	1.23	1.30	V
Reference Drift	$T_A = T_{MIN}$ to T_{MAX}		50			50		ppm/ $^{\circ}C$
Oscillator Frequency		130	170	210	130	160	190	kHz
Compensation Pin Impedance			7500			7500		Ω

Note 1: Output voltage tolerance over temperature is $\pm 4.5\%$ plus external feedback resistor tolerances for adjustable devices (MAX750/MAX758).

Note 2: The standby current typically settles to 25 μA (over temperature) within 2 seconds; however, to decrease test time, the part is guaranteed at a 100 μA maximum value.

Note 3: Shutdown input thresholds not tested, but guaranteed by design.

Typical Operating Characteristics

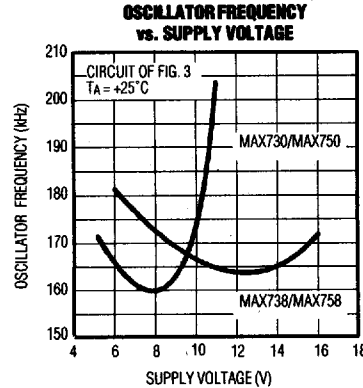
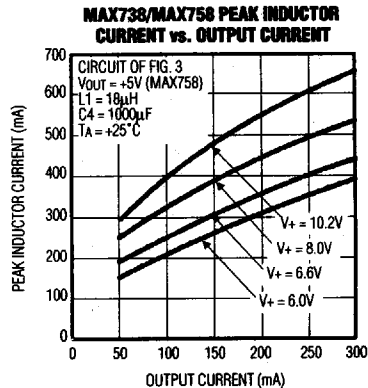
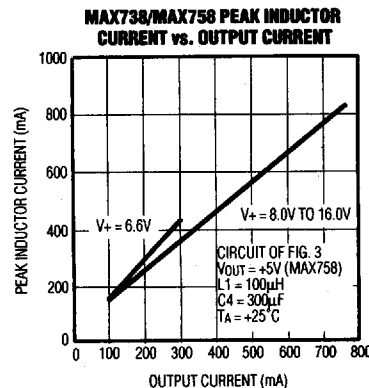
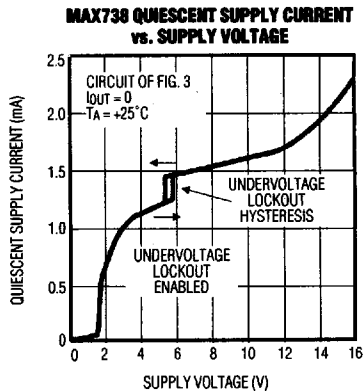
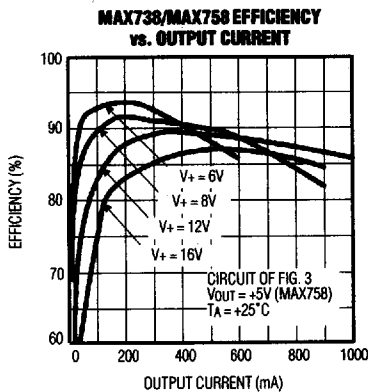
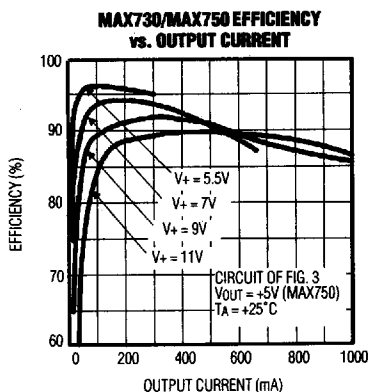

T-58-11-31

+5V and Adjustable Step-Down Current-Mode PWM Regulators

Typical Operating Characteristics (continued)

MAX730/738/750/758

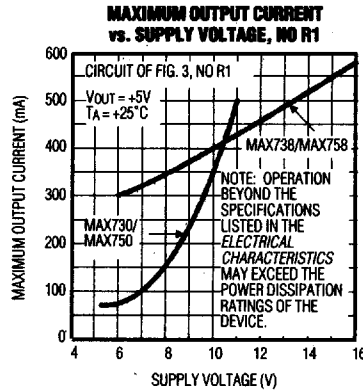
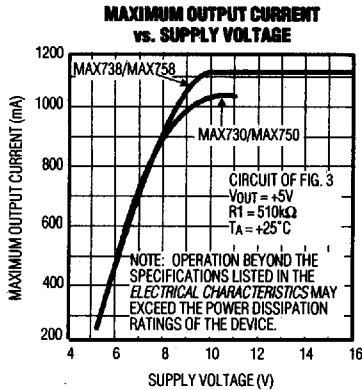

SWITCHING WAVEFORMS CONTINUOUS CONDUCTION

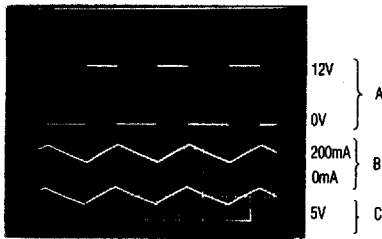

2 μs /div

- A: SWITCH VOLTAGE (LX PIN), 5V/DIV, 0V TO +12V
- B: INDUCTOR CURRENT, 200mA/DIV
- C: OUTPUT VOLTAGE RIPPLE, 50mV/DIV

MAX738/MAX758, CIRCUIT OF FIG. 3, $C_{OUT} = 390\mu F$, $V_+ = 12V$, $I_{OUT} = 150mA$, $T_A = +25^\circ C$

SWITCHING WAVEFORMS DISCONTINUOUS CONDUCTION

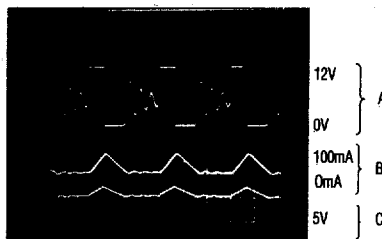

2 μs /div

- A: SWITCH VOLTAGE (LX PIN), 5V/DIV, 0V TO +12V
- B: INDUCTOR CURRENT, 100mA/DIV
- C: OUTPUT VOLTAGE RIPPLE, 50mV/DIV

MAX738/MAX758, CIRCUIT OF FIG. 3, $C_{OUT} = 390\mu F$, $V_+ = 12V$, $I_{OUT} = 150\mu A$, $T_A = +25^\circ C$

MAX730/MAX750 LINE-TRANSIENT RESPONSE

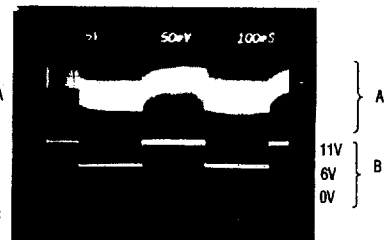

100ms/div

- A: V_{OUT} , 50mV/DIV, DC-COUPLED
- B: V_+ , 5V/DIV, 6.0V TO 11.0V

CIRCUIT OF FIG. 3, $I_{OUT} = 300mA$, $T_A = +25^\circ C$

MAX738/MAX758 LINE-TRANSIENT RESPONSE

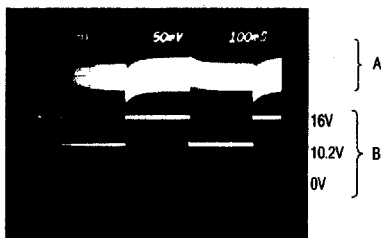

100ms/div

- A: V_{OUT} , 50mV/DIV, DC-COUPLED
- B: V_+ , 5V/DIV, 10.2V TO 16.0V

CIRCUIT OF FIG. 3, $I_{OUT} = 750mA$, $T_A = +25^\circ C$

MAX730/MAX750 LOAD-TRANSIENT RESPONSE

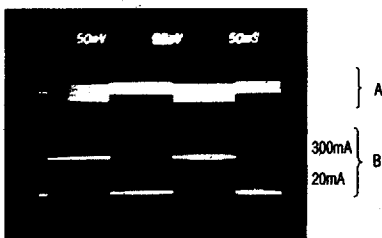

50ms/div

- A: V_{OUT} , 50mV/DIV, DC-COUPLED
- B: I_{OUT} , 200mA/DIV, 20mA TO 300mA

CIRCUIT OF FIG. 3, $V_+ = 9V$, $T_A = +25^\circ C$

MAX738/MAX758 LOAD-TRANSIENT RESPONSE

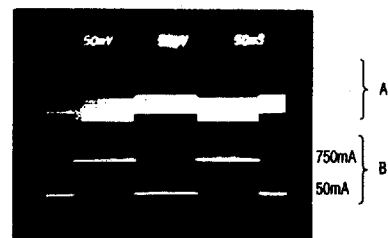

50ms/div

- A: V_{OUT} , 50mV/DIV, DC-COUPLED
- B: I_{OUT} , 500mA/DIV, 50mA TO 750mA

CIRCUIT OF FIG. 3, $V_+ = 12V$, $T_A = +25^\circ C$

+5V and Adjustable Step-Down Current-Mode PWM Regulators

Pin Description

MAX730/738/750/758

PIN # 8-PIN DIP/SO	PIN # 16-PIN WIDE SO	NAME	FUNCTION
1	2	SHDN	Shutdown – active low. Ground to power-down chip, tie to V+ for normal operation. Output voltage falls to 0V when SHDN is low.
2	3	VREF	Reference Voltage Output (+1.23V) supplies up to 100µA for external loads. Bypass to GND with a capacitor that does not exceed 0.047µF.
3	7	SS	Soft-Start. Capacitor between SS and GND provides SS and short-circuit protection. 510kΩ resistor from SS to SHDN provides current boost.
4	8	CC	MAX730/MAX738 Compensation Capacitor Input externally compensates the outer feedback loop. Connect to VOUT with a 330pF capacitor.
			MAX750/MAX758 External voltage divider feedback point. When an external voltage divider is connected from the output voltage to CC and GND, this pin becomes the feedback input for adjustable output operation. A 330pF compensation capacitor must be used between the output voltage and the CC pin.
5	9	VOUT	MAX730/MAX738 Output-Voltage Sense Input provides regulation feedback sensing. Connect to +5V output.
		I.C.	MAX750/MAX758 Internal Connection. Do not connect to anything.
6	10, 11	GND	Ground pins are internally connected.
7	12, 13, 14	LX	Drain of internal P-channel power MOSFET.
8	1, 15, 16	V+	Supply Voltage Input. Bypass to GND with 0.1µF ceramic and large value electrolytic capacitors in parallel. The 0.1µF capacitor must be as close to the device as possible.
	4, 5, 6	N.C.	No Connect – no internal connections to these pins.

4

Operating Principle

The MAX730/738/750/758 switch-mode regulators use a current-mode pulse-width modulation (PWM) control system coupled with a simple buck regulator topography. They convert an unregulated DC voltage from the ranges specified in Table 1 to a lower voltage. The current-mode PWM architecture provides cycle-by-cycle current limiting, improved load transient response characteristics, and simpler outer-loop design.

Table 1. Input Voltage Range

PART	MIN (V)	MAX (V)
MAX730	5.2	11.0
MAX750	4.0	11.0
MAX738	6.0	16.0
MAX758	4.0	16.0

Detailed Description

The controller consists of two feedback loops: an inner (current) loop that monitors the switch current via the current-sense resistor and amplifier, and an outer (voltage) loop that monitors the output voltage through the error amplifier (Figure 1). The inner loop performs cycle-by-cycle current limiting, truncating the power transistor on-time when the switch current reaches a predetermined threshold. This threshold is determined by the outer loop. For example, a sagging output voltage produces an error signal that raises the threshold, allowing the circuit to store and transfer more energy during each cycle.

Programmable Soft-Start

Figures 1 and 2 show a capacitor and a resistor connected to the Soft-Start (SS) pin to ensure an orderly power-up. Typical values are 0.1µF and 510kΩ. SS controls both the SS timing and the maximum output

+5V and Adjustable Step-Down Current-Mode PWM Regulators

MAX730/738/750/758

current that can be delivered while maintaining regulation.

The charging capacitor slowly raises the clamp on the error-amplifier output voltage, limiting surge currents at power-up by slowly increasing the cycle-by-cycle current-limit threshold. The 510Ω resistor sets the SS clamp at a value high enough to maintain regulation, even at currents exceeding 1A. This resistor is not necessary for lower current loads. Refer to *Typical Operating Characteristics, Maximum Output Current vs. Supply Voltage*. Table 2 lists timing characteristics for selected capacitor values and circuit conditions.

The output sags if more than the maximum load current is drawn, and the overcurrent comparator trips if the load exceeds approximately 1.5A. An SS cycle is actively initiated when either an undervoltage or overcurrent fault condition triggers an internal transistor to momentarily discharge the SS capacitor to ground. An SS cycle is

also enabled at power-up and when coming out of the shutdown mode.

Overcurrent Limiting

When the load current exceeds approximately 1.5A, the output stage is turned off by the inner loop cycle-by-cycle current-limiting action, and the overcurrent comparator signals the control logic to initiate an SS cycle. On each clock cycle, the output FET turns on again and attempts to deliver current until cycle-by-cycle or overcurrent limits are exceeded. Note that the SS capacitor must be greater than 0.01μF for overcurrent protection to function properly.

Undervoltage Lockout

The undervoltage lockout feature monitors the supply voltage at V+ and allows operation to continue for supply voltages greater than 5.7V (typ) with 0.25V hysteresis for the MAX738 and 3.750V (typ) with 0.25V hysteresis for the MAX758 (see *Typical Operating Characteristics*,

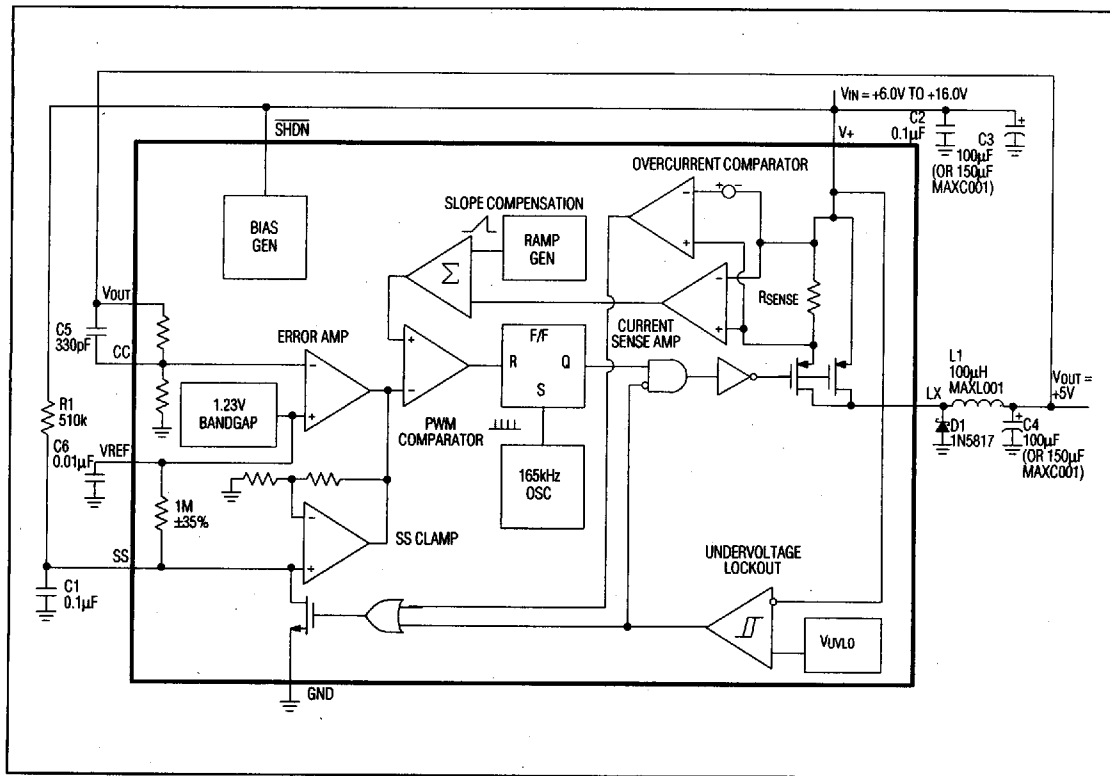

Figure 1. MAX730/MAX738 Detailed Block Diagram with External Components

+5V and Adjustable Step-Down Current-Mode PWM Regulators

Table 2. Typical Soft-Start Times

MAX730/MAX750 Circuit Conditions				Soft-Start Time (ms) vs. C1 (μF)			
R1 (kΩ)	V+ (V)	I _{OUT} (mA)	C4 (μF)	0.01μF (ms)	0.047μF (ms)	0.1μF (ms)	0.47μF (ms)
510	6	0	100	2	6	11	28
510	9	0	100	1	4	6	15
510	11	0	100	1	2	4	11
510	9	150	100	1	4	8	21
510	9	300	100	1	5	9	27
510	9	150	390	3	6	9	23
510	9	150	680	4	6	9	24
none	6	0	100	16	34	51	125
none	9	0	100	10	22	34	82
none	11	0	100	8	18	28	66
none	9	150	100	34	134	270	1263
none	9	150	390	39	147	280	1275
none	9	150	680	40	152	285	1280

MAX738/MAX758 Circuit Conditions				Soft-Start Time (ms) vs. C1 (μF)			
R1 (kΩ)	V+ (V)	I _{OUT} (mA)	C4 (μF)	0.01μF (ms)	0.047μF (ms)	0.1μF (ms)	0.47μF (ms)
510	7	0	100	1	4	6	18
510	12	0	100	1	2	3	8
510	16	0	100	1	1	2	6
510	12	300	100	1	3	5	3
510	12	750	100	1	5	8	21
none	7	0	100	12	27	40	100
none	12	0	100	7	16	25	54
none	16	0	100	6	13	20	68
none	12	300	100	27	112	215	1114

MAX730/738/750/758

4

+5V and Adjustable Step-Down Current-Mode PWM Regulators

MAX730/738/750/758

MAX738 Quiescent Supply Current vs. Supply Voltage. The MAX730 and MAX750 have a typical threshold of 4.7V and 3.75V, respectively. When an undervoltage condition is detected, control logic turns off the output power FET and discharges the SS capacitor to ground. This prevents partial turn-on of the power MOSFET and avoids excessive power dissipation. The control logic holds the output power FET off until the supply voltage rises above approximately 4.95V (MAX730), 5.95V (MAX738), and 3.95V (MAX750/MAX758), when an SS cycle begins.

Shutdown Mode

The MAX730/738/750/758 are held in shutdown mode by keeping SHDN at ground. In shutdown mode, the output drops to 0V and the output power FET is held in an off state. The internal reference also turns off, which causes the SS capacitor to discharge. Typical standby current in shutdown mode is 6 μ A. The actual design limit for standby current is much less than the 100 μ A specified in the *Electrical Characteristics* table. However, testing to tighter limits is prohibitive because the current takes several seconds to settle to a final value. For normal operation, connect SHDN to V+. Coming out of shutdown mode initiates an SS cycle.

Internal Reference

The +1.23V bandgap reference supplies up to 100 μ A at VREF. A bypass capacitor from VREF to GND is required and must not exceed 0.047 μ F.

Oscillator

The internal oscillators of the MAX730/MAX750 typically operate at 170kHz (160kHz for the MAX738/MAX758). Temperature stability over the military temperature range is about 0.06%/°C.

Application Information

Fixed +5V and Adjustable Output Step-Down Converter Application

Figure 3 shows both the standard 5V and the adjustable step-down application circuits. These circuits are useful in systems that require high current and high efficiency and are powered by an unregulated supply, such as a battery or wall-plug AC-DC transformer. These circuits will operate over the entire line, load, and temperature ranges using the single set of component values shown. All components shown are suitable for the MAX730/738/750/758. The actual value of the input and output capacitors is not critical as long as it is greater than 100 μ F, has low ESR, and has sufficient voltage rating.

The MAX738/MAX758 deliver a guaranteed 5V at 300mA for supply voltages of 6.6V to 16.0V, and a guaranteed 5V at 750mA for supply voltages of 10.2V to 16.0V. The MAX738/MAX758 operate from supplies down to 6.0V and 4.0V, respectively (the upper limit of undervoltage lockout), but some reduction of the maximum output current may occur. The MAX730/MAX750 input voltages can be as low as 5.2V and 4.0V respectively, but the maximum output current may also be lower.

Inductor Selection

The MAX730/MAX738 require no inductor design because they are tested in-circuit, and are guaranteed to deliver the power specified in the *Electrical Characteristics* with high efficiency using a single 100 μ H inductor. The 100 μ H inductor's incremental saturation current rating should be greater than 1A for 750mA load operation. Table 3 shows recommended inductor types and suppliers for various applications. 100 μ H through-hole inductors (MAXL001) are available from Maxim in production quantities. The surface-mount inductors have nearly equivalent efficiencies to the larger-sized through-hole inductors.

Adjustable Output

For other output voltages, the MAX750/MAX758 have adjustable outputs from 1.25V to the input voltage. To adjust for other output voltages, connect a voltage divider to the compensation capacitor input (CC) pin as shown in Figure 3.

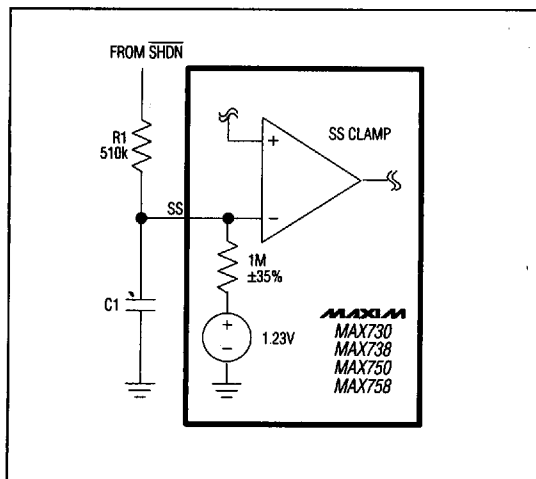

Figure 2. Block Diagram of Soft-Start Circuitry

+5V and Adjustable Step-Down Current-Mode PWM Regulators

The output voltage is set by R2 and R3 as follows:

Let R3 be any resistance in the 10kΩ to 1MΩ range, typically 100kΩ, then:

$$R2 = R3 \left(\frac{V_{OUT}}{1.23V} - 1 \right)$$

Output tolerance over temperature is ±4.5% plus external resistor tolerances.

Low Input Supply Voltage Operation

A unique aspect of these devices is that they are guaranteed to deliver their specified power even at low input voltages. Normally, the output voltage ripples at the converter switching frequency. For a 5V output and at supply voltages less than about 6.8V (MAX730/MAX750) or 7.6V (MAX738/MAX758), the output ripple is no longer at the switching frequency

only, but also at subharmonics of the switching frequency. Efficiency and regulation are unchanged under these conditions, but if this subharmonic ripple is undesirable, a smaller (18μH) inductor value may be appropriate.

To minimize subharmonic output ripple over the entire low supply voltage range of the MAX738/MAX758 (6.6V to 10.2V, up to 300mA), a single inductor value of 18μH can be used in combination with a larger output filter capacitor (1000μF). Using the 18μH inductor results in about a 5% to 10% efficiency drop when compared to the 100μH inductor. The subharmonic output ripple at low input voltages in the MAX730/MAX750 is not remedied by this solution.

MAX730/738/750/758

4

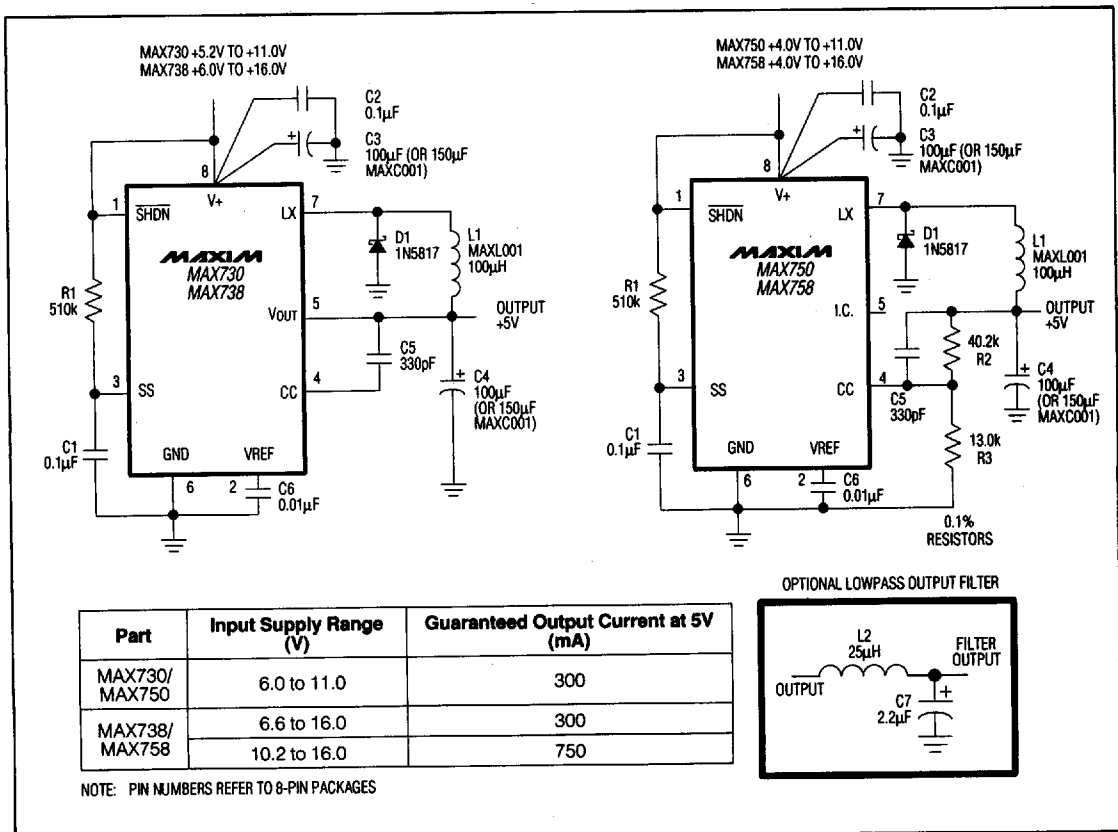

Figure 3. Standard +5V Step-Down Application Circuit

+5V and Adjustable Step-Down Current-Mode PWM Regulators

MAX730/738/750/758

Table 3. Component Suppliers

Production Method	Inductors	Capacitors
Surface Mount	Sumida (708) 956-0666 CD54-101KC (MAX730) CD105-101KC (MAX738) Coiltronics (305) 781-8900 CTX100-series	Matsuo (714) 969-2491 267-series
Miniature Through-Hole	Sumida (708) 956-0666 RCH654-101K (MAX730) RCH895-101K (MAX738)	Sanyo (619) 661-6322 OS-CON-series Low ESR Organic Semiconductor
Low-Cost Through-Hole	Maxim MAXL001 100µH Iron-Powder Toroid Renco (516) 586-5566 RL1284-100	Maxim MAXC001 150µF, Low ESR Electrolytic Nichicon (708) 843-7500 PL-series Low ESR Electrolytics United Chemicon (708) 696-2000 LXF-series

Output Filter Capacitor Selection

The primary criterion for selecting the output filter capacitor is low equivalent series resistance (ESR). The product of the inductor current variation and the ESR of the output capacitor determines the amplitude of the sawtooth ripple seen on the output voltage. In addition, the ESR of the output filter capacitor should be minimized to maintain AC stability. The ESR of the capacitor should be less than 0.25Ω to keep the output ripple less than 50mVp-p over the entire current range (using a 100µH inductor). The ESR of capacitors goes up as the capacitor temperature goes down. For this reason, ESR must be considered for operation at less than 0°C to keep ripple at an acceptable level. Refer to Table 3 for suggested capacitor suppliers.

Other Components

The catch diode should be a Schottky or high-speed silicon rectifier with a peak current rating of at least 1.5A for full-load (750mA) operation. The 1N5817 is a good choice. The 330pF outer-loop compensation capacitor provides the widest input voltage range and best transient characteristics. For low-current applications, the 510kΩ resistor may be omitted (see *Typical Operating Characteristics, Maximum Output Current vs. Supply Voltage, No R1*).

Printed Circuit Layouts

A good layout is essential for clean, stable operation. The layouts and component placement diagrams given in Figures 4, 5, 6, and 7 have been successfully tested over a wide range of operating conditions. This board layout is configured for a fixed +5V output, but can be modified

for the MAX750/MAX758 adjustable output. To configure for adjustable output voltages: 1. Turn the board solder side up. 2. Cut the trace between the two through holes at pin 5. 3. Determine the value of R2 and R3. 4. Install at these positions. Note that the 0.1µF input bypass capacitor must be positioned as close to the pins as possible. Also, the output capacitor should be as close to the VOUT and GND pins as possible. The traces connecting ground to the input and output filter capacitors and to the catch diode must be short to reduce inductance.

Thermal Considerations

The MAX730/738/750/758 do not require a heat sink for normal operation. Operation at load currents above those guaranteed in the Electrical Characteristics may require a heat sink. The ambient temperature plus the temperature rise caused by power dissipation in the device must not exceed the junction temperature ratings (see *Absolute Maximum Ratings*). The junction-to-air thermal coefficients of the packages are +105°C/W (16-pin wide SO), +125°C/W (8-pin CERDIP), +120°C/W (8-lead plastic DIP), +170°C/W (8-pin SO). The temperature rise of the device is the product of the thermal coefficient and the power dissipated in the device.

Output-Ripple Filtering

A simple lowpass pi-filter (Figure 3) can be added to the output to reduce output ripple to about 5mVp-p. The cutoff frequency shown is 21kHz. Since the filter inductor is in series with the circuit output, its resistance should be kept to a minimum so the voltage drop across it is not excessive.

+5V and Adjustable Step-Down Current-Mode PWM Regulators

MAX730/738/750/758

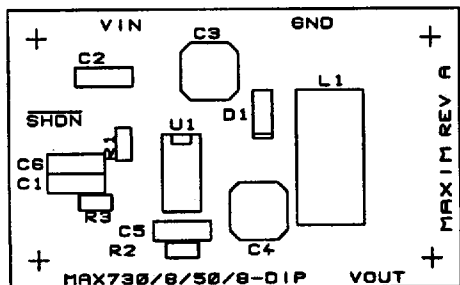

Figure 4. DIP PC Layout, Through-Hole Component Placement Diagram (1X Scale)

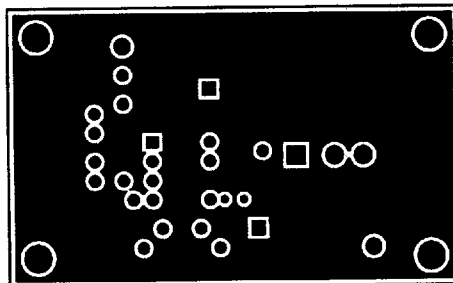

Figure 5. DIP PC Layout, Component Side (1X Scale)

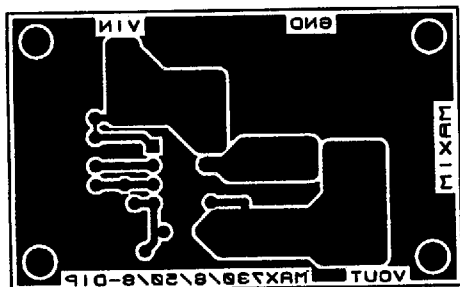

Figure 6. DIP PC Layout, Solder Side (1X Scale)

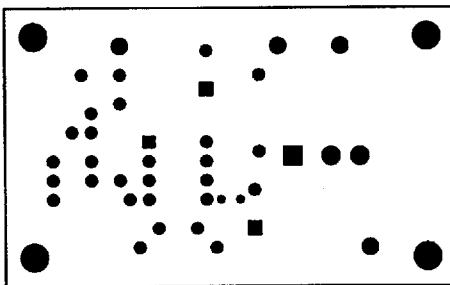

Figure 7. DIP PC Layout, Drill Guide (1X Scale)

+5V and Adjustable Step-Down Current-Mode PWM Regulators

MAX730/738/750/758

Ordering Information (continued)

PART	TEMP. RANGE	PIN-PACKAGE
MAX750CPA	0°C to +70°C	8 Plastic DIP
MAX750CSA	0°C to +70°C	8 SO
MAX750C/D	0°C to +70°C	Dice*
MAX750EPA	-40°C to +85°C	8 Plastic DIP
MAX750ESA	-40°C to +85°C	8 SO
MAX750MJA	-55°C to +125°C	8 CERDIP**
MAX758CPA	0°C to +70°C	8 Plastic DIP
MAX758CWE	0°C to +70°C	16 Wide SO
MAX758C/D	0°C to +70°C	Dice*
MAX758EPA	-40°C to +85°C	8 Plastic DIP
MAX758EWE	-40°C to +85°C	16 Wide SO
MAX758MJA	-55°C to +125°C	8 CERDIP**

* Contact factory for dice specifications.

** Contact factory for availability and processing to MIL-STD-883.

Chip Topographies

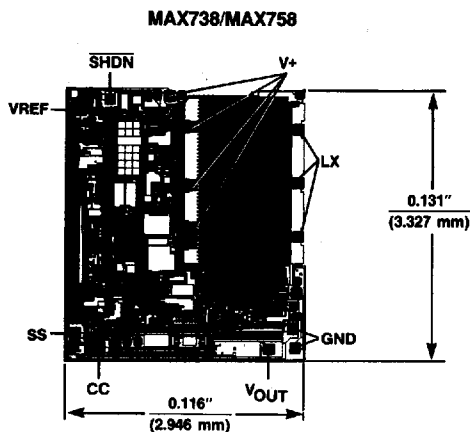
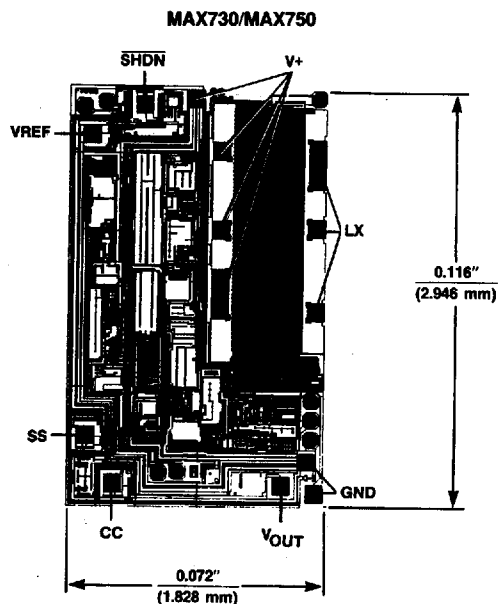

Pin Configurations (continued)

TOP VIEW

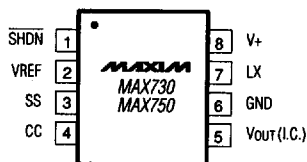

SO

NOTE: () ARE FOR MAX750.

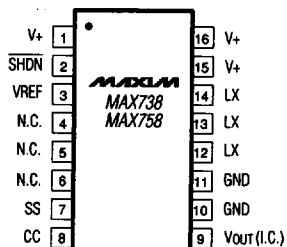

WIDE SO

NOTE: () ARE FOR MAX758.

NOTES: () ARE FOR MAX750/MAX758, DO NOT USE.
CONNECT SUBSTRATE TO V+.
TRANSISTOR COUNT 274 (MAX730/MAX750)
286 (MAX738/MAX758)

Maxim cannot assume responsibility for use of any circuitry other than circuitry entirely embodied in a Maxim product. No circuit patent licenses are implied. Maxim reserves the right to change the circuitry and specifications without notice at any time.