

TOSHIBA GTR MODULE SILICON N CHANNEL IGBT

MG50J6ES50

HIGH POWER SWITCHING APPLICATIONS.

Unit in mm

MOTOR CONTROL APPLICATIONS.

- The Electrodes are Isolated from Case.
- High Input Impedance.
- 6 IGBTs Built Into 1 Package.
- Enhancement-Mode.
- High Speed : $t_f = 0.30\mu s$ (Max.) ($I_C = 50A$)
 $t_{rr} = 0.15\mu s$ (Max.) ($I_F = 50A$)
- Low Saturation Voltage
: $V_{CE(sat)} = 2.70V$ (Max.) ($I_C = 50A$)

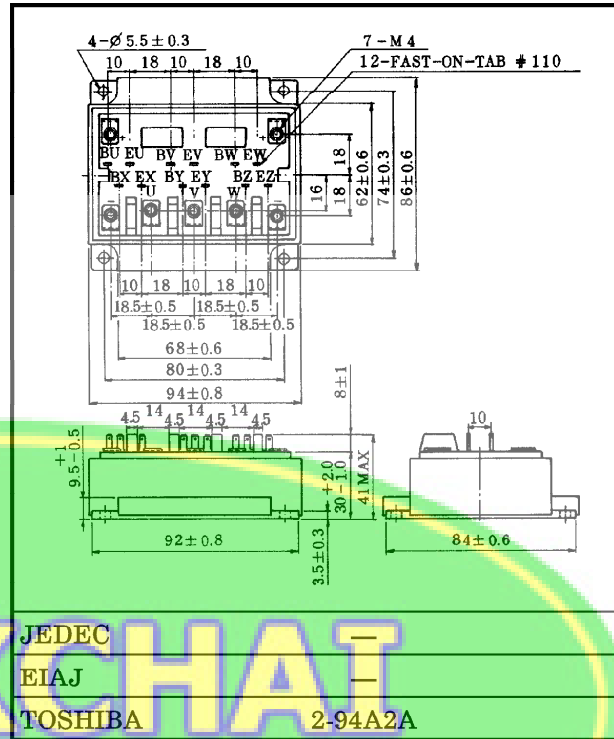

Weight : 505g (Typ.)

EQUIVALENT CIRCUIT

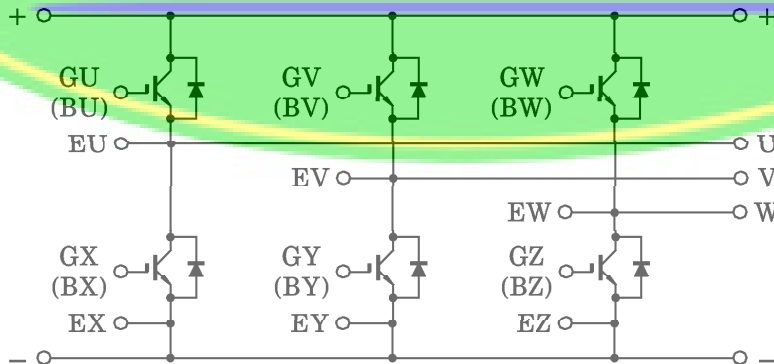

961001EAA2

- TOSHIBA is continually working to improve the quality and the reliability of its products. Nevertheless, semiconductor devices in general can malfunction or fail due to their inherent electrical sensitivity and vulnerability to physical stress. It is the responsibility of the buyer, when utilizing TOSHIBA products, to observe standards of safety, and to avoid situations in which a malfunction or failure of a TOSHIBA product could cause loss of human life, bodily injury or damage to property. In developing your designs, please ensure that TOSHIBA products are used within specified operating ranges as set forth in the most recent products specifications. Also, please keep in mind the precautions and conditions set forth in the TOSHIBA Semiconductor Reliability Handbook.
- The information contained herein is presented only as a guide for the applications of our products. No responsibility is assumed by TOSHIBA CORPORATION for any infringements of intellectual property or other rights of the third parties which may result from its use. No license is granted by implication or otherwise under any intellectual property or other rights of TOSHIBA CORPORATION or others.
- The information contained herein is subject to change without notice.

MAXIMUM RATINGS (Ta = 25°C)

CHARACTERISTIC		SYMBOL	RATING	UNIT
Collector-Emitter Voltage		V _{CES}	600	V
Gate-Emitter Voltage		V _{GES}	±20	V
Collector Current	DC	I _C	50	A
	1ms	I _{CP}	100	
Forward Current	DC	I _F	50	A
	1ms	I _{FM}	100	
Collector Power Dissipation (Tc = 25°C)		P _C	280	W
Junction Temperature		T _j	150	°C
Storage Temperature Range		T _{stg}	-40~125	°C
Isolation Voltage		V _{Isol}	2500 (AC 1Min.)	V
Screw Torque (Terminal/Mounting)		—	2/3	N·m

ELECTRICAL CHARACTERISTICS (Ta = 25°C)

CHARACTERISTIC		SYMBOL	TEST CONDITION	MIN.	TYP.	MAX.	UNIT
Gate Leakage Current		I _{GES}	V _{GE} = ±20V, V _{CE} = 0	—	—	±500	nA
Collector Cut-off Current		I _{CES}	V _{CE} = 600V, V _{GE} = 0	—	—	1.0	mA
Gate-Emitter Cut-off Voltage		V _{GE (off)}	I _C = 5mA, V _{CE} = 5V	5.0	7.0	8.0	V
Collector-Emitter Saturation Voltage		V _{CE (sat)}	I _C = 50A, V _{GE} = 15V	—	2.10	2.70	V
Input Capacitance		C _{ies}	V _{CE} = 10V, V _{GE} = 0, f = 1MHz	—	4950	—	pF
Switching Time	Turn-on Delay Time	t _{d (on)}	Inductive Load V _{CC} = 300V I _C = 50A V _{GE} = ±15V R _G = 24Ω (Note 1)	—	0.08	0.16	μs
	Rise Time	t _r		—	0.12	0.24	
	Turn-on Time	t _{on}		—	0.40	0.80	
	Turn-off Delay Time	t _{d (off)}		—	0.20	0.40	
	Fall Time	t _f		—	0.15	0.30	
	Turn-off Time	t _{off}		—	0.50	1.00	
Forward Voltage		V _F	I _F = 50A, V _{GE} = 0	—	2.30	3.00	V
Reverse Recovery Time		t _{rr}	I _F = 50A, V _{GE} = -10V di / dt = 100A / μs	—	0.08	0.15	μs
Thermal Resistance	R _{th (j-c)}	Transistor		—	—	0.45	°C / W
		Diode		—	—	0.90	

Note 1 Switching Time Test Circuit & Timing Chart

