

# PM300CSD060

FLAT-BASE TYPE  
INSULATED PACKAGE

## PM300CSD060



### FEATURE

- a) Adopting new 4th generation planar IGBT chip, which performance is improved by 1μm fine rule process.  
For example, typical  $V_{CE(sat)}=1.7V$
- b) Using new Diode which is designed to get soft reverse recovery characteristics.
  - 3φ 300A, 600V Current-sense IGBT for 15kHz switching
  - Monolithic gate drive & protection logic
  - Detection, protection & status indication circuits for over-current, short-circuit, over-temperature & under-voltage (P-Fo available from upper leg devices)
  - Acoustic noise-less 30kW class inverter application
  - UL Recognized Yellow Card No.E80276(N)  
File No.E80271

### APPLICATION

General purpose inverter, servo drives and other motor controls

### PACKAGE OUTLINES

Dimensions in mm

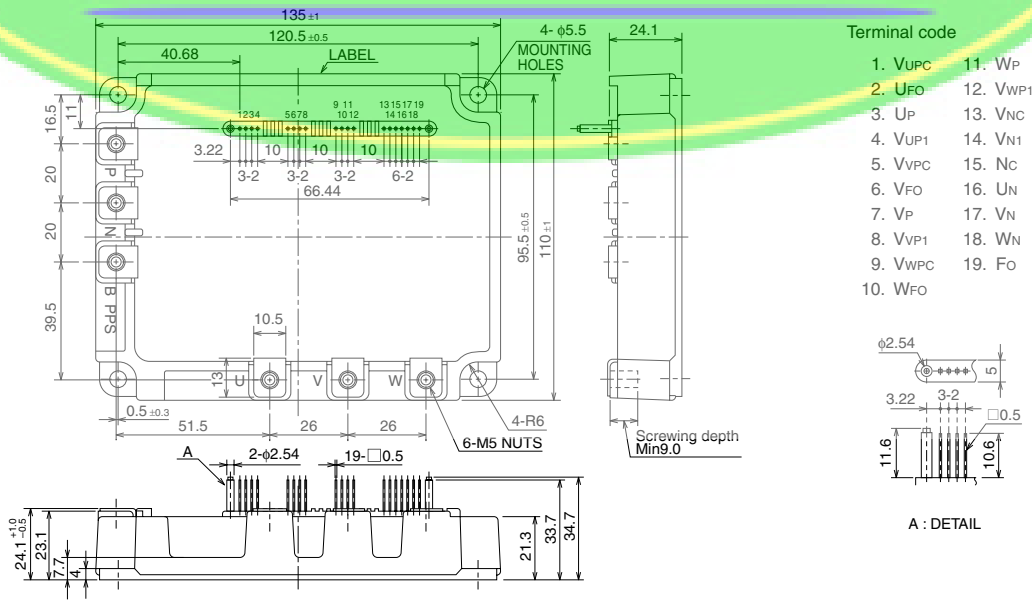

# PM300CSD060

FLAT-BASE TYPE  
INSULATED PACKAGE

## INTERNAL FUNCTIONS BLOCK DIAGRAM

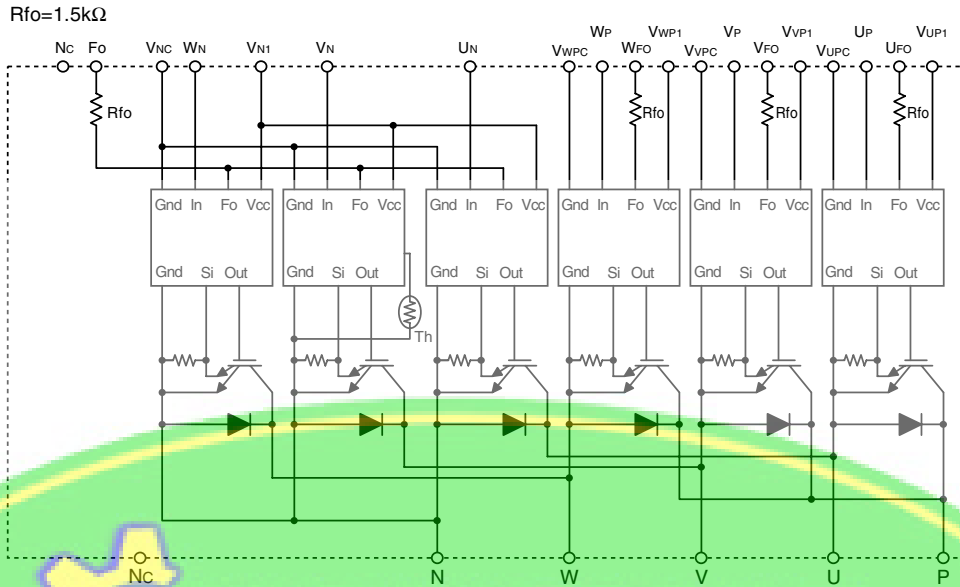

MAXIMUM RATINGS (Tj = 25°C, unless otherwise noted)

### INVERTER PART

| Symbol           | Parameter                 | Condition                                    | Ratings    | Unit |
|------------------|---------------------------|--|------------|------|
| V <sub>CES</sub> | Collector-Emitter Voltage | V <sub>D</sub> = 15V, V <sub>CIN</sub> = 15V | 600        | V    |
| ±I <sub>C</sub>  | Collector Current         | T <sub>C</sub> = 25°C                        | 300        | A    |
| ±I <sub>CP</sub> | Collector Current (Peak)  | T <sub>C</sub> = 25°C                        | 600        | A    |
| P <sub>C</sub>   | Collector Dissipation     | T <sub>C</sub> = 25°C                        | 781        | W    |
| T <sub>j</sub>   | Junction Temperature      |  | -20 ~ +150 | °C   |

### CONTROL PART

| Symbol           | Parameter                   | Condition   | Ratings | Unit |
|------------------|-----------------------------|---|---------|------|
| V <sub>D</sub>   | Supply Voltage              | Applied between : V <sub>UP1</sub> -V <sub>UPC</sub><br>V <sub>Vp1</sub> -V <sub>VPC</sub> , V <sub>Wp1</sub> -V <sub>WPC</sub> , V <sub>N1</sub> -V <sub>Nc</sub>                            | 20      | V    |
| V <sub>CIN</sub> | Input Voltage               | Applied between : U <sub>P</sub> -V <sub>UPC</sub> , V <sub>P</sub> -V <sub>VPC</sub><br>W <sub>P</sub> -V <sub>WPC</sub> , U <sub>N</sub> • V <sub>N</sub> • W <sub>N</sub> -V <sub>Nc</sub> | 20      | V    |
| V <sub>FO</sub>  | Fault Output Supply Voltage | Applied between : U <sub>FO</sub> -V <sub>UPC</sub> , V <sub>FO</sub> -V <sub>VPC</sub> , W <sub>FO</sub> -V <sub>WPC</sub><br>F <sub>O</sub> -V <sub>Nc</sub>                                | 20      | V    |
| I <sub>FO</sub>  | Fault Output Current        | Sink current at U <sub>FO</sub> , V <sub>FO</sub> , W <sub>FO</sub> , F <sub>O</sub> terminals  | 20      | mA   |

# PM300CSD060

FLAT-BASE TYPE  
INSULATED PACKAGE

## TOTAL SYSTEM

| Symbol                 | Parameter                           | Condition   | Ratings    | Unit             |
|------------------------|-------------------------------------|---|------------|------------------|
| V <sub>CC(prot)</sub>  | Supply Voltage Protected by OC & SC | V <sub>D</sub> = 13.5 ~ 16.5V, Inverter Part,<br>T <sub>j</sub> = 125°C Start | 400        | V                |
| V <sub>CC(surge)</sub> | Supply Voltage (Surge)              | Applied between : P-N, Surge value or without switching                       | 500        | V                |
| T <sub>c</sub>         | Module Case Operating Temperature   | (Note-1)  | -20 ~ +100 | °C               |
| T <sub>stg</sub>       | Storage Temperature                 |   | -40 ~ +125 | °C               |
| V <sub>iso</sub>       | Isolation Voltage                   | 60Hz, Sinusoidal, Charged part to Base, AC 1 min.                             | 2500       | V <sub>rms</sub> |

(Note-1) T<sub>c</sub> measurement point is as shown below. (Base plate depth 3mm)

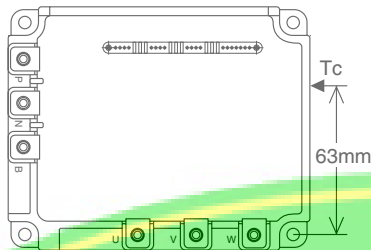

## THERMAL RESISTANCES

| Symbol                | Parameter                            | Test Condition                               | Limits   |      |      | Unit |
|-----------------------|--------------------------------------|--|--|------|------|------|
|                       |                                      |  | Min.   | Typ. | Max. |      |
| R <sub>th(j-c)Q</sub> | Junction to case Thermal Resistances | Inverter IGBT part (per 1 element), (Note-1) | —  | —    | 0.16 | °C/W |
| R <sub>th(j-c)F</sub> |                                      | Inverter FWDi part (per 1 element), (Note-1) | —  | —    | 0.24 |      |
| R <sub>th(j-c)Q</sub> |                                      | Inverter IGBT part (per 1 element), (Note-2) | —  | —    | 0.10 |      |
| R <sub>th(j-c)F</sub> |                                      | Inverter FWDi part (per 1 element), (Note-2) | —  | —    | 0.16 |      |
| R <sub>th(c-f)</sub>  |                                      | Contact Thermal Resistance                   | Case to fin, Thermal grease applied (per 1 module) | —    | —    |      |

(Note-2) T<sub>C</sub> measurement point is just under the chips.

If you use this value, R<sub>th(f-a)</sub> should be measured just under the chips.

## ELECTRICAL CHARACTERISTICS (T<sub>j</sub> = 25°C, unless otherwise noted)

### INVERTER PART

| Symbol               | Parameter                            | Test Condition   | Limits                 |      |      | Unit |    |
|----------------------|--------------------------------------|--|------------------------|------|------|------|----|
|                      |                                      |  | Min.                   | Typ. | Max. |      |    |
| V <sub>CE(sat)</sub> | Collector-Emitter Saturation Voltage | V <sub>D</sub> = 15V, I <sub>c</sub> = 300A<br>V <sub>CIN</sub> = 0V, Pulsed (Fig. 1)                                      | T <sub>j</sub> = 25°C  | —    | 1.7  | 2.3  | V  |
|                      |                                      |  | T <sub>j</sub> = 125°C | —    | 1.7  | 2.3  |    |
| V <sub>EC</sub>      | FWDi Forward Voltage                 | -I <sub>c</sub> = 300A, V <sub>D</sub> = 15V, V <sub>CIN</sub> = 15V (Fig. 2)  | —                      | 2.2  | 3.3  | V    |    |
| t <sub>on</sub>      | Switching Time                       | V <sub>D</sub> = 15V, V <sub>CIN</sub> = 15V↔0V<br>V <sub>CC</sub> = 300V, I <sub>c</sub> = 300A<br>T <sub>j</sub> = 125°C | —                      | 0.4  | 0.8  | 2.0  | μs |
| t <sub>tr</sub>      |                                      |  | —                      | —    | 0.15 | 0.3  |    |
| t <sub>c(on)</sub>   |                                      |  | —                      | —    | 0.4  | 1.0  |    |
| t <sub>off</sub>     |                                      |  | —                      | —    | 2.0  | 2.9  |    |
| t <sub>c(off)</sub>  |                                      |  | —                      | —    | 0.6  | 1.2  |    |
| I <sub>CES</sub>     | Collector-Emitter Cutoff Current     | V <sub>CE</sub> = V <sub>CEs</sub> , V <sub>CIN</sub> = 15V (Fig. 4)   | T <sub>j</sub> = 25°C  | —    | —    | 1    | mA |
|                      |                                      |  | T <sub>j</sub> = 125°C | —    | —    | 10   |    |

# PM300CSD060

FLAT-BASE TYPE  
INSULATED PACKAGE

## CONTROL PART

| Symbol               | Parameter                               | Test Condition  | Limits                             |      |      | Unit |    |
|----------------------|---|---|------------------------------------|------|------|------|----|
|                      |   |   | Min.                               | Typ. | Max. |      |    |
| Id                   | Circuit Current                         | V <sub>D</sub> = 15V, V <sub>CIN</sub> = 15V  | V <sub>N1</sub> -V <sub>Nc</sub>   | —    | 52   | 72   | mA |
|                      |   |   | V <sub>XP1</sub> -V <sub>XPC</sub> | —    | 13   | 18   |    |
| V <sub>th(ON)</sub>  | Input ON Threshold Voltage              | Applied between : UP-VU <sub>PC</sub> , VP-VV <sub>PC</sub> , WP-VW <sub>PC</sub><br>UN • VN • WN-V <sub>Nc</sub> |                                    | 1.2  | 1.5  | 1.8  | V  |
| V <sub>th(OFF)</sub> | Input OFF Threshold Voltage             |   |                                    | 1.7  | 2.0  | 2.3  |    |
| OC                   | Over Current Trip Level                 | V <sub>D</sub> = 15V (Fig. 5.6)   | T <sub>j</sub> = -20°C             | —    | —    | 1270 | A  |
|                      |   |   | T <sub>j</sub> = 25°C              | 651  | 766  | 1060 |    |
|                      |   |   | T <sub>j</sub> = 125°C             | 390  | —    | —    |    |
| SC                   | Short Circuit Trip Level                | -20 ≤ T <sub>j</sub> ≤ 125°C, V <sub>D</sub> = 15V (Fig. 5.6)   | —                                  | 760  | —    | A    |    |
| t <sub>off(OC)</sub> | Over Current Delay Time                 | V <sub>D</sub> = 15V (Fig. 5.6)   | —                                  | 10   | —    | μs   |    |
| OT                   | Over Temperature Protection             | Base-plate<br>Temperature detection, V <sub>D</sub> = 15V   | Trip level                         | 111  | 118  | 125  | °C |
|                      |   |   | Reset level                        | —    | 100  | —    |    |
| UV                   | Supply Circuit Under-Voltage Protection | -20 ≤ T <sub>j</sub> ≤ 125°C  | Trip level                         | 11.5 | 12.0 | 12.5 | V  |
|                      |   |   | Reset level                        | —    | 12.5 | —    |    |
| I <sub>FO(H)</sub>   | Fault Output Current                    | V <sub>D</sub> = 15V, V <sub>FO</sub> = 15V (Note-3)  |                                    | —    | —    | 0.01 | mA |
| I <sub>FO(L)</sub>   |   |   |                                    | —    | 10   | 15   |    |
| t <sub>FO</sub>      | Minimum Fault Output Pulse Width        | V <sub>D</sub> = 15V (Note-3)   | 1.0                                | 1.8  | —    | ms   |    |

(Note-3) Fault output is given only when the internal OC, SC, OT & UV protection.  
 Fault output of OC, SC and UV protection operate by upper and lower arms.  
 Fault output of OT protection operate by lower arm.  
 Fault output of OC, SC protection given pulse.  
 Fault output of OT, UV protection given pulse while over level.

## MECHANICAL RATINGS AND CHARACTERISTICS

| Symbol | Parameter       | Test Condition           | Limits |      |      | Unit  |
|--------|-----------------|--------------------------|--------|------|------|-------|
|        |                 |                          | Min.   | Typ. | Max. |       |
| —      | Mounting torque | Main terminal screw : M5 | 2.5    | 3.0  | 3.5  | N • m |
| —      | Mounting torque | Mounting part screw : M5 | 2.5    | 3.0  | 3.5  | N • m |
| —      | Weight          | —                        | —      | 920  | —    | g     |

## RECOMMENDED CONDITIONS FOR USE

| Symbol                | Parameter                       | Test Condition   | Recommended value | Unit |
|-----------------------|---------------------------------|--|-------------------|------|
| V <sub>CC</sub>       | Supply Voltage                  | Applied across P-N terminals   | ≤ 400             | V    |
| V <sub>D</sub>        | Control Supply Voltage          | Applied between : V <sub>UP1</sub> -V <sub>U<sub>PC</sub></sub> , V <sub>VP1</sub> -V <sub>V<sub>PC</sub></sub><br>V <sub>WP1</sub> -V <sub>W<sub>PC</sub></sub> , V <sub>N1</sub> -V <sub>Nc</sub> (Note-4) | 15 ± 1.5          | V    |
| V <sub>CIN(ON)</sub>  | Input ON Voltage                | Applied between : UP-VU <sub>PC</sub> , VP-VV <sub>PC</sub> , WP-VW <sub>PC</sub><br>UN • VN • WN-V <sub>Nc</sub>  | ≤ 0.8             | V    |
| V <sub>CIN(OFF)</sub> | Input OFF Voltage               |  | ≥ 4.0             |      |
| f <sub>PWM</sub>      | PWM Input Frequency             | Using Application Circuit input signal of IPM, 3φ sinusoidal PWM VVVF inverter (Fig. 8)  | ≤ 20              | kHz  |
| t <sub>dead</sub>     | Arm Shoot-through Blocking Time | For IPM's each input signals (Fig. 7)  | ≥ 2.5             | μs   |

(Note-4) Allowable Ripple rating of Control Voltage : dv/dt ≤ ±5V/μs, 2V<sub>p-p</sub>

# PM300CSD060

FLAT-BASE TYPE  
INSULATED PACKAGE

## PRECAUTIONS FOR TESTING

- Before applying any control supply voltage ( $V_D$ ), the input terminals should be pulled up by resistors, etc. to their corresponding supply voltage and each input signal should be kept off state.  
After this, the specified ON and OFF level setting for each input signal should be done.
- When performing "OC" and "SC" tests, the turn-off surge voltage spike at the corresponding protection operation should not be allowed to rise above  $V_{CES}$  rating of the device.  
(These test should not be done by using a curve tracer or its equivalent.)

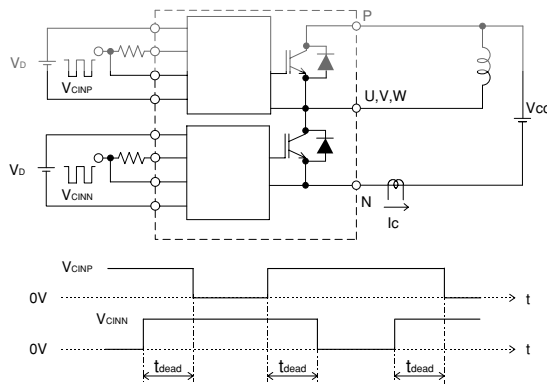
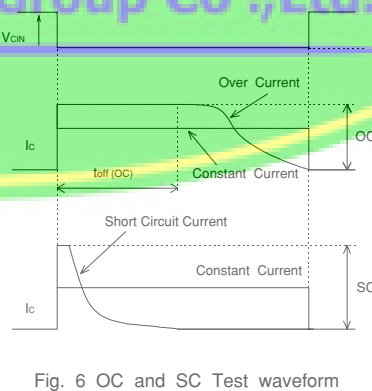
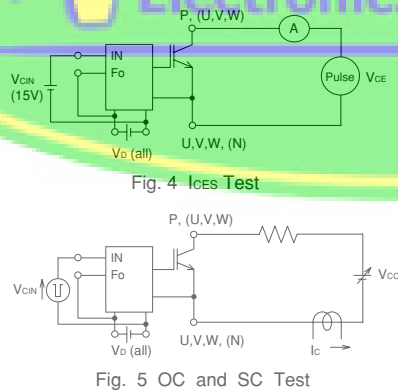
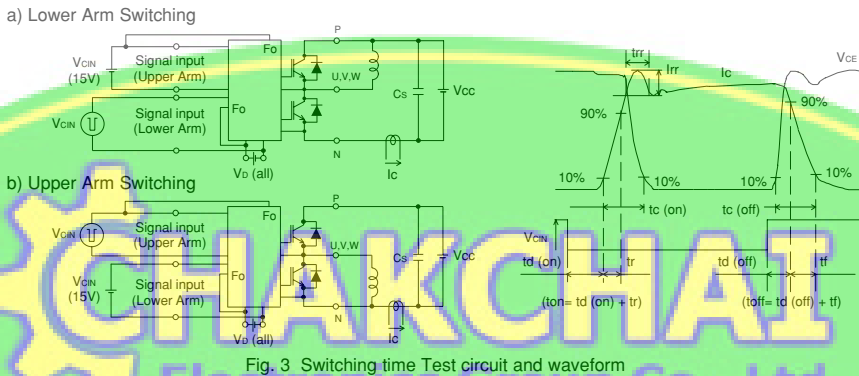
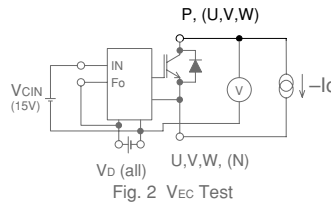
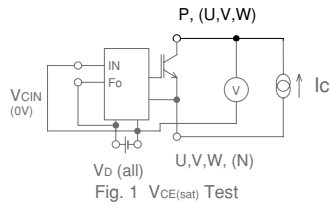

PM300CSD060

FLAT-BASE TYPE  
INSULATED PACKAGE

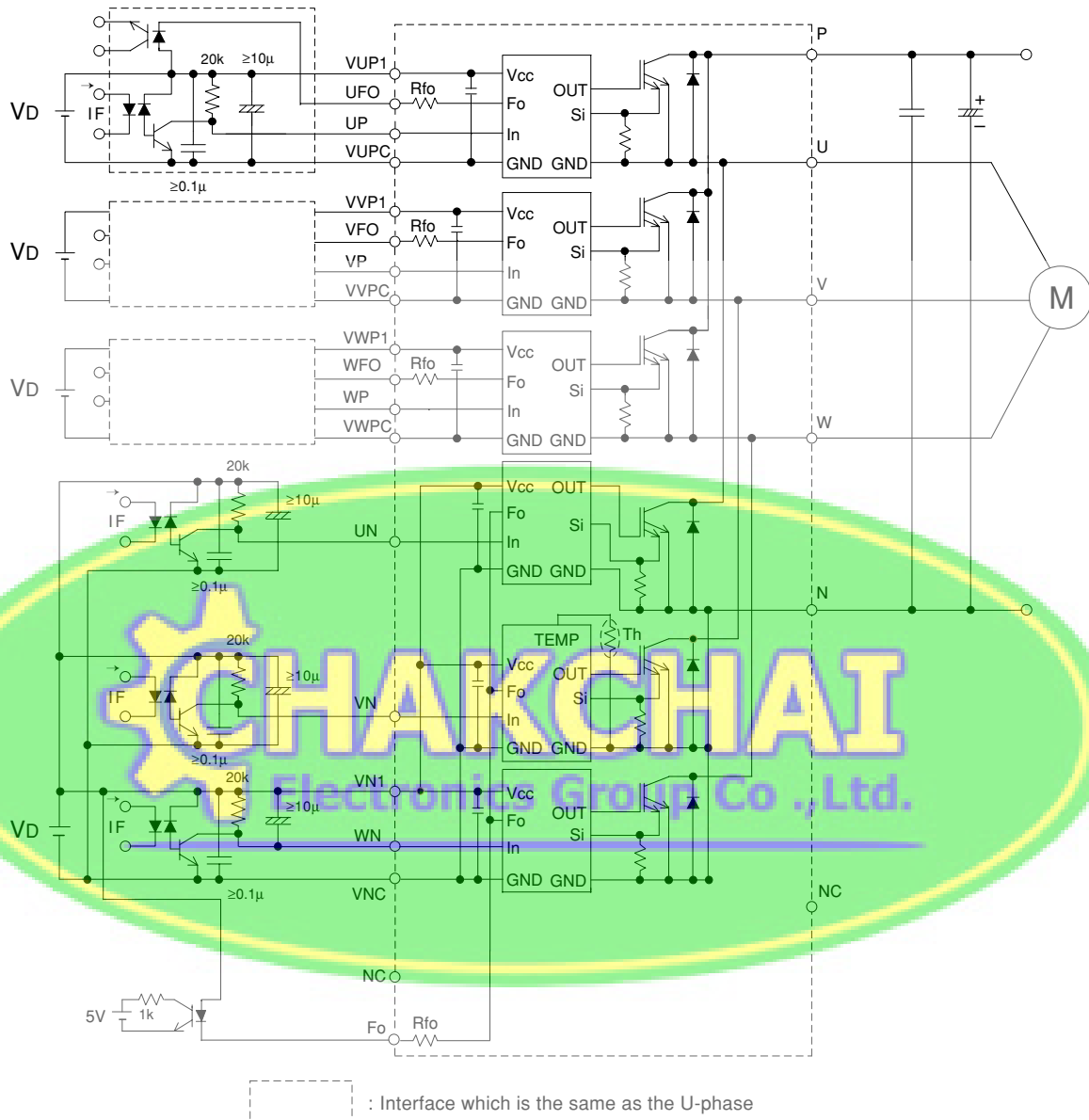

Fig. 8 Application Example Circuit

**NOTES FOR STABLE AND SAFE OPERATION ;**

- Design the PCB pattern to minimize wiring length between opto-coupler and IPM's input terminal, and also to minimize the stray capacity between the input and output wirings of opto-coupler.
- Quick opto-couplers:  $T_{PLH}, T_{PHL} \leq 0.8\mu s$ . Use High CMR type. The line between opto-coupler and intelligent module should be shortened as much as possible to minimize the floating capacitance.
- Slow switching opto-coupler: recommend to use at  $CTR = 100 \sim 200\%$ , Input current = 8 ~ 10mA, to work in active.
- Use 4 isolated control power supplies (VD). Also, care should be taken to minimize the instantaneous voltage charge of the power supply.
- Make inductance of DC bus line as small as possible, and minimize surge voltage using snubber capacitor between P and N terminal.
- Use line noise filter capacitor (ex. 4.7nF) between each input AC line and ground to reject common-mode noise from AC line and improve noise immunity of the system.

**PM300CSD060**

FLAT-BASE TYPE  
INSULATED PACKAGE

**PERFORMANCE CURVES**

**OUTPUT CHARACTERISTICS (TYPICAL)**

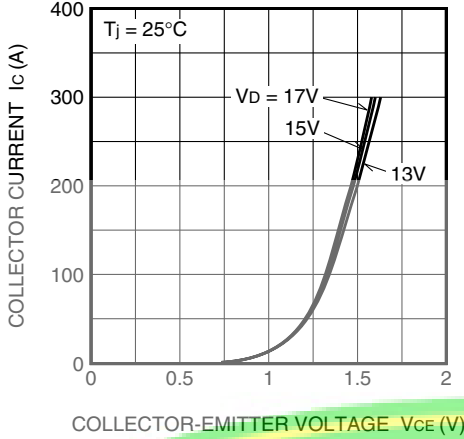

**COLLECTOR-EMITTER SATURATION VOLTAGE (VS.  $I_c$ ) CHARACTERISTICS (TYPICAL)**

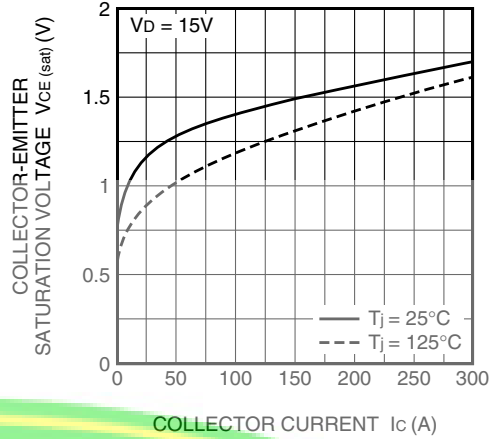

**COLLECTOR-EMITTER SATURATION VOLTAGE (VS.  $V_D$ ) CHARACTERISTICS (TYPICAL)**

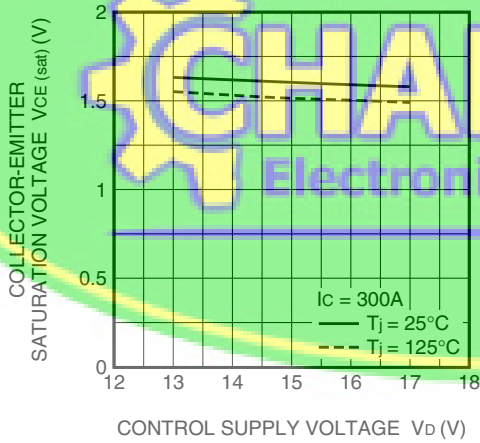

**SWITCHING TIME CHARACTERISTICS (TYPICAL)**

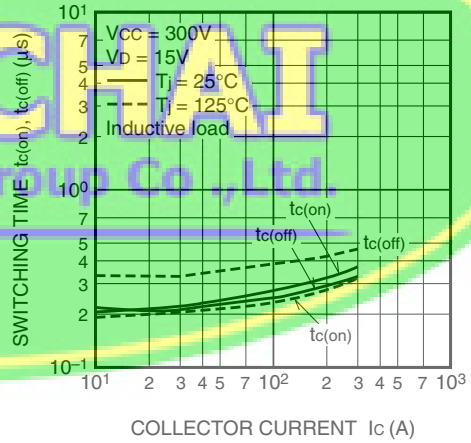

**SWITCHING TIME CHARACTERISTICS (TYPICAL)**

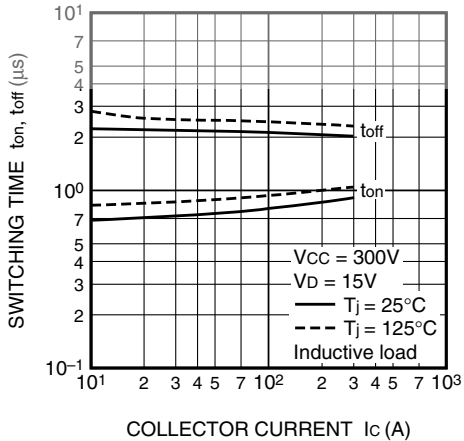

**SWITCHING LOSS CHARACTERISTICS (TYPICAL)**

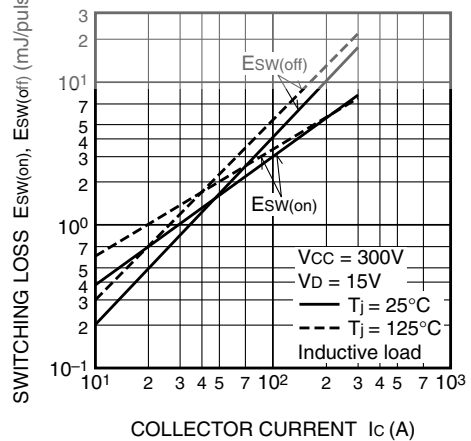

# PM300CSD060

FLAT-BASE TYPE  
INSULATED PACKAGE

