

CMOS 8-Bit Microcontroller

**TMP87C840N, TMP87CC40N, TMP87CH40N, TMP87CK40AN, TMP87CM40AN**  
**TMP87C840F, TMP87CC40F, TMP87CH40F, TMP87CK40AF, TMP87CM40AF**

The 87C840/C40/H40/K40A/M40A are the high speed and high performance 8-bit single chip microcomputers. These MCU contain CPU core, ROM, RAM, input/output ports, an A/D converter, six multi-function timer / counters, two serial interfaces, and two clock generators on a chip. The 87C840/C40/H40/K40A/M40A provide high current output capability for LED direct drive.

Part No	ROM	RAM	Package	OTP MCU
TMP87C840N	8K x 8-bit	256 x 8-bit	P-SDIP64-750-1.78	TMP87PH40AN
TMP87C840F			P-QFP64-1420-1.00A	TMP87PH40AF
TMP87CC40N	12K x 8-bit	512 x 8-bit	P-SDIP64-750-1.78	TMP87PH40AN
TMP87CC40F			P-QFP64-1420-1.00A	TMP87PH40AF
TMP87CH40N	16K x 8-bit	512 x 8-bit	P-SDIP64-750-1.78	TMP87PH40AN
TMP87CH40F			P-QFP64-1420-1.00A	TMP87PH40AF
TMP87CK40AN	24K x 8-bit	1024 x 8-bit	P-SDIP64-750-1.78	TMP87PM40AN
TMP87CK40AF			P-QFP64-1420-1.00A	TMP87PM40AF
TMP87CM40AN	32K x 8-bit	1024 x 8-bit	P-SDIP64-750-1.78	TMP87PM40AN
TMP87CM40AF			P-QFP64-1420-1.00A	TMP87PM40AF

**Features**

- ◆ 8-bit single chip microcomputer TLCS-870 Series
- ◆ Instruction execution time: 0.5 μs (at 8 MHz), 122 μs (at 32.768 kHz)
- ◆ 412 basic instructions
  - Multiplication and Division (8bits x 8bits , 16bits ÷ 8bits)
  - Bit manipulations (Set/Clear/Complement/Move/Test/Exclusive or)
  - 16-bit data operations
  - 1-byte jump/subroutine-call (Short relative jump / Vector call)
- ◆ 15 interrupt sources (External: 6, Internal: 9)
  - All sources have independent latches each, and nested interrupt control is available.
  - 4 edge-selectable external interrupts with noise reject
  - High-speed task switching by register bank changeover
- ◆ 8 Input/Output ports (56 pins)
  - High current output: 8pins (typ. 20 mA)
- ◆ Two 16-bit Timer/Counters
  - Timer, Event counter, Programmable pulse generator output, Pulse width measurement, External trigger timer, Window modes
- ◆ Two 8-bit Timer/Counters
  - Timer, Event counter, Capture (Pulse width/duty measurement), PWM output, Programmable divider output modes
- ◆ Time Base Timer (Interrupt frequency: 1 Hz to 16 kHz)
- ◆ Divider output function (frequency: 1 Hz to 8 kHz)
- ◆ Watchdog Timer
- ◆ Two 8-bit Serial Interfaces
  - Each 8 bytes transmit/receive data buffer
  - Internal/external serial clock, and 4/8-bit mode
- ◆ 8-bit successive approximate type A/D converter with sample and hold
  - 8 analog inputs
  - Conversion time: 23 μs at 8 MHz
- ◆ Dual clock operation

P-SDIP64-750-1.78

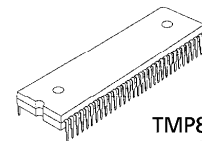

TMP87C840N  
 TMP87CC40N  
 TMP87CH40N  
 TMP87CK40AN  
 TMP87CM40AN  
 TMP87PH40AN  
 TMP87PM40AN

P-QFP64-1420-1.00A

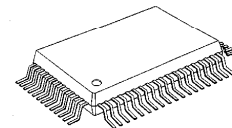

TMP87C840F  
 TMP87CC40F  
 TMP87CH40F  
 TMP87CK40AF  
 TMP87CM40AF  
 TMP87PH40AF  
 TMP87PM40AF

980910EBP2

- For a discussion of how the reliability of microcontrollers can be predicted, please refer to Section 1.3 of the chapter entitled Quality and Reliability Assurance / Handling Precautions.
- TOSHIBA is continually working to improve the quality and the reliability of its products. Nevertheless, semiconductor devices in general can malfunction or fail due to their inherent electrical sensitivity and vulnerability to physical stress. It is the responsibility of the buyer, when utilizing TOSHIBA products, to observe standards of safety, and to avoid situations in which a malfunction or failure of a TOSHIBA product could cause loss of human life, bodily injury or damage to property. In developing your designs, please ensure that TOSHIBA products are used within specified operating ranges as set forth in the most recent products specifications. Also, please keep in mind the precautions and conditions set forth in the TOSHIBA Semiconductor Reliability Handbook.
- The products described in this document are subject to the foreign exchange and foreign trade laws.
- The information contained herein is presented only as a guide for the applications of our products. No responsibility is assumed by TOSHIBA CORPORATION for any infringements of intellectual property or other rights of the third parties which may result from its use. No license is granted by implication or otherwise under any intellectual property or other rights of TOSHIBA CORPORATION or others.
- The information contained herein is subject to change without notice.

- ◆ Five Power saving operating modes
  - STOP mode: Oscillation stops. Battery/Capacitor back-up. Port output hold/high-impedance.
  - SLOW mode: Low power consumption operation using low-frequency clock (32.768 kHz).
  - IDLE1 mode: CPU stops, and Peripherals operate using high-frequency clock. Release by interrupts.
  - IDLE2 mode: CPU stops, and Peripherals operate using high and low frequency clock. Release by interrupts.
  - SLEEP mode: CPU stops, and Peripherals operate using low-frequency clock. Release by interrupts.
- ◆ Wide operating voltage: 2.7 to 6 V at 4.19 MHz/32.768 kHz, 4.5 to 6 V at 8 MHz/32.768 kHz (87C840/C40/H40, 87PH40A/M40A)  
2.7 to 5.5 V at 4.19 MHz/32.768 kHz,  
4.5 to 5.5 V at 8 MHz/32.768 kHz (87CK40A/M40A)
- ◆ Emulation Pod: BM87CK40N0B

Pin Assignments (Top View)

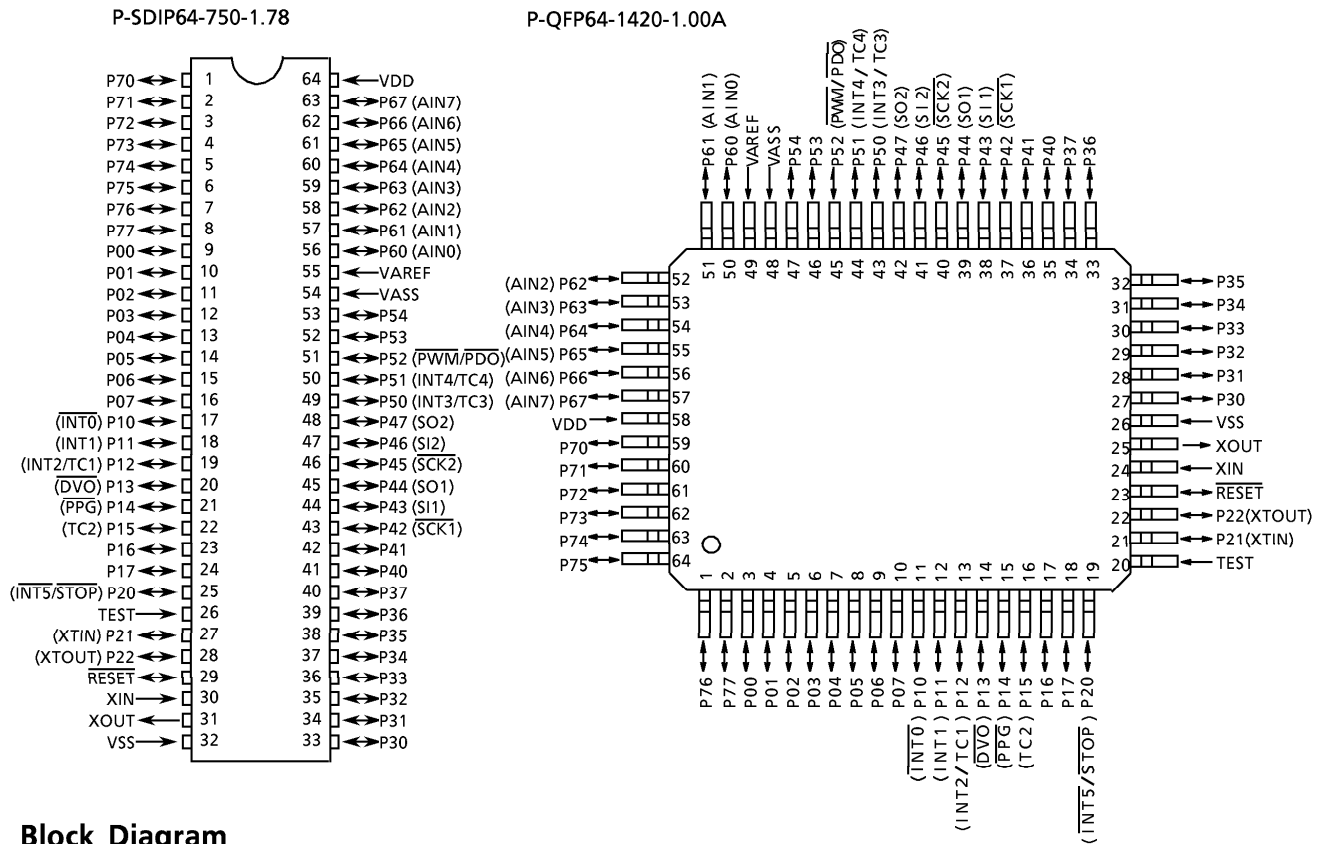

Block Diagram

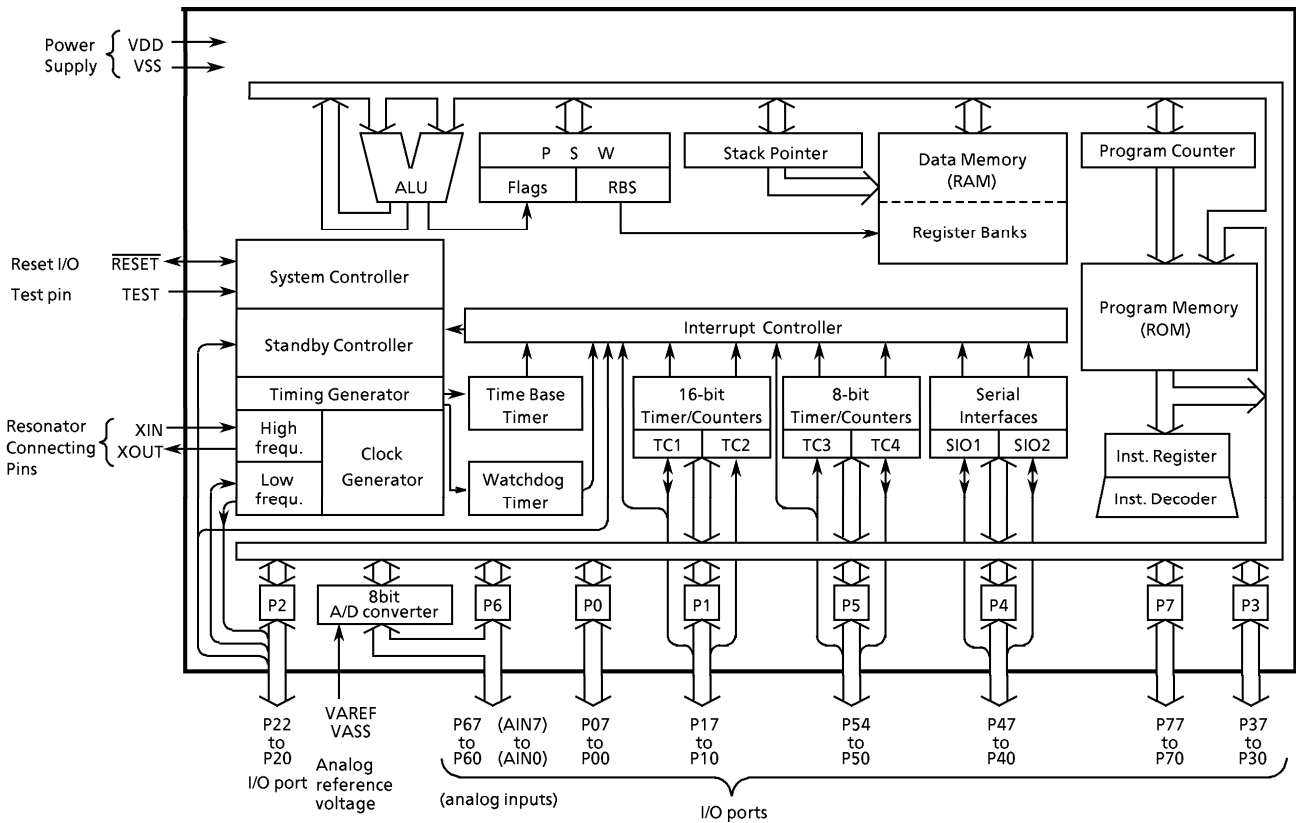

## Pin Function

Pin Name	Input / Output	Function		
P07 to P00	I/O	Two 8-bit programmable input/output ports (tri-state).		
P17, P16	I/O			
P15 (TC2)	I/O (Input)	Each bit of these ports can be individually configured as an input or an output under software control. During reset, all bits are configured as inputs. When used as a divider output or a PPG output, the latch must be set to "1".	Timer/Counter 2 input	
P14 (PPG)	I/O (Output)		Programmable pulse generator output	
P13 (DVO)			Divider output	
P12 (INT2 / TC1)			External interrupt input 2 or Timer/Counter 1 input	
P11 (INT1)	I/O (Input)		External interrupt input 1	
P10 (INT0)			External interrupt input 0	
P22 (XTOUT)	I/O (Output)		3-bit input/output port with latch. When used as an input port, the latch must be set to "1".	Resonator connecting pins (32.768 kHz). For inputting external clock, XTIN is used and XTOUT is opened.
P21 (XTIN)	I/O (Input)			
P20 (INT5 / STOP)		External interrupt input 5 or STOP mode release signal input		
P37 to P30	I/O	8-bit input/output port (high current output) with latch. When used as an input port, the latch must be set to "1".		
P47 (SO2)	I/O (Output)	8-bit input/output port with latch. When used as an input port or a SIO input/output, the latch must be set to "1".	SIO2 serial data output	
P46 (SI2)	I/O (Input)		SIO2 serial data input	
P45 (SCK2)	I/O (I/O)		SIO2 serial clock input/output	
P44 (SO1)	I/O (Output)		SIO1 serial data output	
P43 (SI1)	I/O (Input)		SIO1 serial data input	
P42 (SCK1)	I/O (I/O)		SIO1 serial clock input/output	
P41, P40	I/O			
P54, P53	I/O		5-bit input/output port with latch.	
P52 (PWM/PDO)	I/O (Output)	When used as an input port, an external interrupt input, or a PWM/PDO output, the latch must be set to "1".	8-bit PWM output or 8-bit programmable divider output	
P51 (INT4/TC4)			External interrupt input 4 or Timer/Counter 4 input	
P50 (INT3/TC3)	I/O (Input)		External interrupt input 3 or Timer/Counter 3 input	
P67 (AIN7) to P60 (AIN0)	I/O (Input)	8-bit programmable input/output port (tri-state). Each bit of the port can be individually configured as an input or an output under software control.	A/D converter analog inputs	
P77 to P70	I/O	8-bit programmable input/output port (tri-state). Each bit of the port can be individually configured as an input or an output under software control. During reset, all bits are configured as input.		
XIN, XOUT	Input, Output	Resonator connecting pins for high-frequency clock. For inputting external clock, XIN is used and XOUT is opened.		
RESET	I/O	Reset signal input or watchdog timer output/address-trap-reset output/system-clock-reset output.		
TEST	Input	Test pin for out-going test. Be tied to low.		
VDD, VSS	Power Supply	+ 5 V, 0 V (GND)		
VAREF, VASS		Analog reference voltage inputs (High, Low)		

Operational Description

1. CPU Core Functions

The CPU core consists of a CPU, a system clock controller, an interrupt controller, and a watchdog timer. This section provides a description of the CPU core, the program memory (ROM), the data memory (RAM), and the reset circuit.

1.1 Memory Address Map

The TLCS-870 Series is capable of addressing 64K bytes of memory. Figure 1-1 shows the memory address maps of the 87C840/C40/H40/K40A/M40A. In the TLCS-870 Series, the memory is organized 4 address spaces (ROM, RAM, SFR, and DBR). It uses a memory mapped I/O system, and all I/O registers are mapped in the SFR/DBR address spaces. There are 16 banks of general-purpose registers. The register banks are also assigned to the first 128 bytes of the RAM address space.

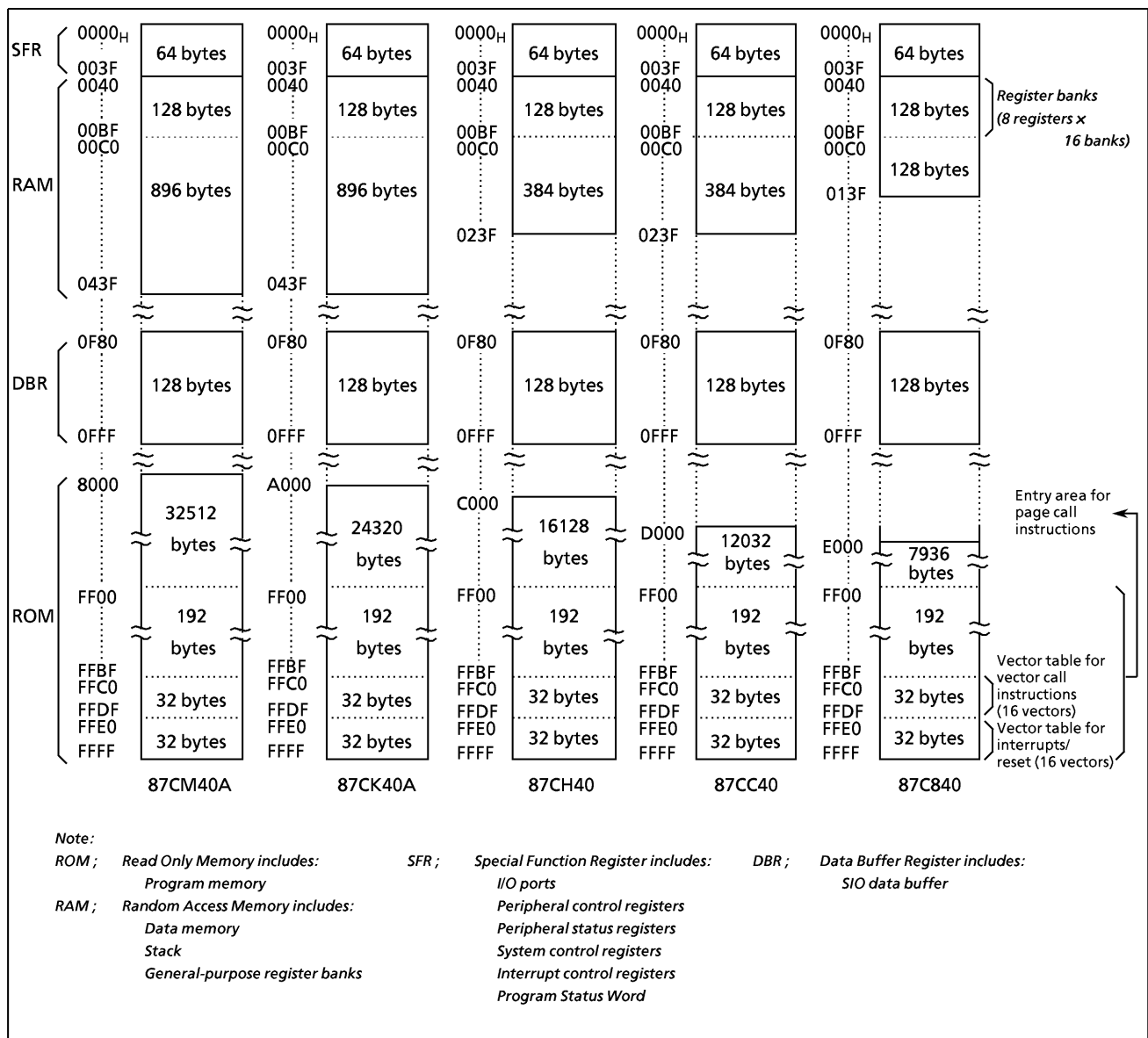

Figure 1-1. Memory Address Maps

Electrical Characteristics

(1) 87C840/C40/H40

Absolute Maximum Ratings (V<sub>SS</sub> = 0V)

Parameter	Symbol	Conditions	Ratings	Unit
Supply Voltage	V <sub>DD</sub>		- 0.3 to 7	V
Input Voltage	V <sub>IN</sub>		- 0.3 to V <sub>DD</sub> + 0.3	V
Output Voltage	V <sub>OUT1</sub>	Except for sink open drain pin , but include P2 and RESET	- 0.3 to V <sub>DD</sub> + 0.3	V
	V <sub>OUT2</sub>	Sink open drain pin except for port P2, RESET	- 0.3 to 10	
Output Current (Per 1 pin)	I <sub>OUT1</sub>	Ports P0, P1, P2, P3, P4, P5, P6, P7	3.2	mA
	I <sub>OUT2</sub>	Port P3	30	
Output Current (Total)	Σ I <sub>OUT1</sub>	Ports P0, P1, P2, P4, P5, P6, P7	120	mA
	Σ I <sub>OUT2</sub>	Port P3	120	
Power Dissipation [Topr = 70°C]	PD	TMP87C840N / C40N / H40N / K40N	600	mW
		TMP87C840F / C40F / H40F / K40F	350	
Soldering Temperature (time)	T <sub>sld</sub>		260 (10 s)	°C
Storage Temperature	T <sub>stg</sub>		- 55 to 125	°C
Operating Temperature	Topr		- 30 to 70	°C

Note: The absolute maximum ratings are rated values which must not be exceeded during operation, even for an instant. Any one of the ratings must not be exceeded. If any absolute maximum rating is exceeded, a device may break down or its performance may be degraded, causing it to catch fire or explode resulting in injury to the user. Thus, when designing products which include this device, ensure that no absolute maximum rating value will ever be exceeded.

Recommended Operating Conditions (V<sub>SS</sub> = 0 V, Topr = - 30 to 70°C)

Parameter	Symbol	Pins	Conditions	Min	Max	Unit		
Supply Voltage	V <sub>DD</sub>		f <sub>c</sub> = 8 MHz	NORMAL1, 2 mode	4.5	6.0	V	
				IDLE1, 2 mode				
			f <sub>c</sub> = 4.2 MHz	NORMAL1, 2 mode				2.7
				IDLE1, 2 mode				
			f <sub>s</sub> = 32.768 kHz	SLOW mode				2.0
				SLEEP mode				
	STOP mode							
Input High Voltage	V <sub>IH1</sub>	Except hysteresis input	V <sub>DD</sub> ≥ 4.5 V	V <sub>DD</sub> × 0.70	V <sub>DD</sub>	V		
	V <sub>IH2</sub>	Hysteresis input		V <sub>DD</sub> × 0.75				
	V <sub>IH3</sub>			V <sub>DD</sub> < 4.5 V			V <sub>DD</sub> × 0.90	
Input Low Voltage	V <sub>IL1</sub>	Except hysteresis input	V <sub>DD</sub> ≥ 4.5 V	0	V <sub>DD</sub> × 0.30	V		
	V <sub>IL2</sub>	Hysteresis input			V <sub>DD</sub> × 0.25			
	V <sub>IL3</sub>				V <sub>DD</sub> < 4.5 V		V <sub>DD</sub> × 0.10	
Clock Frequency	f <sub>c</sub>	XIN, XOUT	V <sub>DD</sub> = 4.5 to 6 V	0.4	8.0	MHz		
			V <sub>DD</sub> = 2.7 to 6 V		4.2			
	f <sub>s</sub>	XTIN, XTOUT		30.0	34.0	kHz		

Note: The recommended operating conditions for a device are operating conditions under which it can be guaranteed that the device will operate as specified. If the device is used under operating conditions other than the recommended operating conditions (supply voltage, operating temperature range, specified AC/DC values etc.), malfunction may occur. Thus, when designing products which include this device, ensure that the recommended operating conditions for the device are always adhered to.

**D.C. Characteristics** ( $V_{SS} = 0\text{ V}$ ,  $T_{opr} = -30\text{ to }70\text{ }^{\circ}\text{C}$ )

Parameter	Symbol	Pins	Conditions	Min	Typ.	Max	Unit		
Hysteresis Voltage	$V_{HS}$	Hysteresis inputs		-	0.9	-	V		
Input Current	$I_{IN1}$	TEST	$V_{DD} = 5.5\text{ V}$ $V_{IN} = 5.5\text{ V} / 0\text{ V}$	-	-	$\pm 2$	$\mu\text{A}$		
	$I_{IN2}$	Open drain ports and tri-state ports							
	$I_{IN3}$	RESET, STOP							
Input Low Current	$I_{IL}$	Push-pull ports	$V_{DD} = 5.5\text{ V}$ , $V_{IN} = 0.4\text{ V}$	-	-	-2	mA		
Input Resistance	$R_{IN1}$	P7 with a pull-up resistor		30	70	150	k $\Omega$		
	$R_{IN2}$	RESET		100	220	450			
Output Leakage Current	$I_{LO1}$	Open drain ports	$V_{DD} = 5.5\text{ V}$ , $V_{OUT} = 5.5\text{ V}$	-	-	2	$\mu\text{A}$		
	$I_{LO2}$	Tri-state ports	$V_{DD} = 5.5\text{ V}$ , $V_{OUT} = 5.5\text{ V} / 0\text{ V}$	-	-	$\pm 2$			
Output High Voltage	$V_{OH1}$	Push-pull ports	$V_{DD} = 4.5\text{ V}$ , $I_{OH} = -200\text{ }\mu\text{A}$	2.4	-	-	V		
	$V_{OH2}$	Tri-state ports	$V_{DD} = 4.5\text{ V}$ , $I_{OH} = -0.7\text{ mA}$	4.1	-	-			
Output Low Voltage	$V_{OL}$	Except XOUT and port P3	$V_{DD} = 4.5\text{ V}$ , $I_{OL} = 1.6\text{ mA}$	-	-	0.4	V		
Output Low Current	$I_{OL3}$	Port P3	$V_{DD} = 4.5\text{ V}$ , $V_{OL} = 1.0\text{ V}$	-	20	-	mA		
Supply Current in NORMAL 1, 2 mode	$I_{DD}$		$V_{DD} = 5.5\text{ V}$ $f_c = 8\text{ MHz}$ $f_s = 32.768\text{ kHz}$ $V_{IN} = 5.3\text{ V} / 0.2\text{ V}$	87C840/C40/H40	-	8	14	mA	
				87CK40	-	10	16		
Supply Current in IDLE 1, 2 mode					87C840/C40/H40	-	4	6	mA
					87CK40	-	4.5	6	
Supply Current in SLOW mode					$V_{DD} = 3.0\text{ V}$ $f_s = 32.768\text{ kHz}$ $V_{IN} = 2.8\text{ V} / 0.2\text{ V}$	-	30	60	$\mu\text{A}$
Supply Current in SLEEP mode						-	15	30	$\mu\text{A}$
Supply Current in STOP mode			$V_{DD} = 5.5\text{ V}$ $V_{IN} = 5.3\text{ V} / 0.2\text{ V}$	-	0.5	10	$\mu\text{A}$		

Note 1: Typical values show those at  $T_{opr} = 25^{\circ}\text{C}$ ,  $V_{DD} = 5\text{ V}$ .  
 Note 2: Input Current ; The current through pull-up or pull-down resistor is not included.  
 Note 3:  $I_{DD}$  ; Except for  $I_{REF}$

**A / D Conversion Characteristics** ( $V_{SS} = 0\text{ V}$ ,  $V_{DD} = 4.5\text{ to }6.0\text{ V}$ ,  $T_{opr} = -30\text{ to }70^{\circ}\text{C}$ )

Parameter	Symbol	Conditions	Min	Typ.	Max	Unit
Analog Reference Voltage	$V_{AREF}$	$V_{AREF} - V_{ASS} \geq 2.5\text{ V}$	$V_{DD} - 1.5$	-	$V_{DD}$	V
	$V_{ASS}$		$V_{SS}$	-	1.5	
Analog Input Voltage	$V_{AIN}$		$V_{ASS}$	-	$V_{AREF}$	V
Analog Supply Current	$I_{REF}$	$V_{AREF} = 5.5\text{ V}$ , $V_{ASS} = 0.0\text{ V}$	-	0.5	1.0	mA
Nonlinearity Error		$V_{DD} = 5.0\text{ V}$ , $V_{SS} = 0.0\text{ V}$ $V_{AREF} = 5.000\text{ V}$ $V_{ASS} = 0.000\text{ V}$	-	-	$\pm 1$	LSB
Zero Point Error			-	-	$\pm 1$	
Full Scale Error			-	-	$\pm 1$	
Total Error			-	-	$\pm 2$	

Note : Quantizing Error is not contained in Total Errors.

**A.C. Characteristics** ( $V_{SS} = 0\text{ V}$ ,  $V_{DD} = 4.5\text{ to }6.0\text{ V}$ ,  $T_{opr} = -30\text{ to }70^\circ\text{C}$ )

Parameter	Symbol	Conditions	Min	Typ.	Max	Unit
Machine Cycle Time	$t_{cy}$	In NORMAL 1, 2 mode	0.5	-	10	$\mu\text{s}$
		In IDLE 1, 2 mode				
		In SLOW mode	117.6	-	133.3	
		In SLEEP mode				
High Level Clock Pulse Width	$t_{WCH}$	For external clock operation (XIN input), $f_c = 8\text{ MHz}$	50	-	-	ns
Low Level Clock Pulse Width	$t_{WCL}$					
High Level Clock Pulse Width	$t_{WSH}$	For external clock operation (XTIN input), $f_s = 32.768\text{ kHz}$	14.7	-	-	$\mu\text{s}$
Low Level Clock Pulse Width	$t_{WSL}$					

**Recommended Oscillating Condition** ( $V_{SS} = 0\text{ V}$ ,  $V_{DD} = 4.5\text{ to }6.0\text{ V}$ ,  $T_{opr} = -30\text{ to }70^\circ\text{C}$ )

Parameter	Oscillator	Frequency	Recommended Oscillator	Recommended Condition	
				C <sub>1</sub>	C <sub>2</sub>
High-frequency	Ceramic Resonator	8 MHz	KYOCERA KBR8.0M	30 pF	30 pF
		4 MHz	KYOCERA KBR4.0MS MURATA CSA4.00MG		
	Crystal Oscillator	8 MHz	TOYOCOM 210B 8.0000	20 pF	20 pF
		4 MHz	TOYOCOM 204B 4.0000		
Low-frequency	Crystal Oscillator	32.768 kHz	NDK MX-38T	15 pF	15 pF

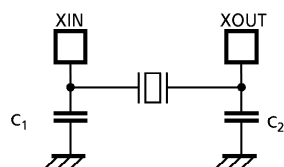

(1) High-frequency

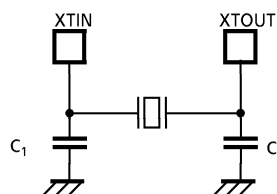

(2) Low-frequency

**Note:** An electrical shield by metal shield plate on the surface of the IC package should be recommendable in order to prevent the device from the high electric field stress applied from CRT (Cathode Ray Tube) for continuous reliable operation.



Electrical Characteristics

(2) 87CK40A/M40A

Absolute Maximum Ratings (V<sub>SS</sub> = 0V)

Parameter	Symbol	Conditions	Ratings	Unit
Supply Voltage	* V <sub>DD</sub>		- 0.3 to 6.5	V
Input Voltage	V <sub>IN</sub>		- 0.3 to V <sub>DD</sub> + 0.3	V
Output Voltage	* V <sub>OUT</sub>		- 0.3 to V <sub>DD</sub> + 0.3	V
Output Current (Per 1 pin)	I <sub>OUT1</sub>	Ports P0, P1, P2, P4, P5, P6, P7	3.2	mA
	I <sub>OUT2</sub>	Port P3	30	
Output Current (Total)	Σ I <sub>OUT1</sub>	Ports P0, P1, P2, P4, P5, P6, P7	120	mA
	Σ I <sub>OUT2</sub>	Port P3	120	
Power Dissipation [Topr = 70°C]	PD	TMP87CK40AN/CM40AN	600	mW
		TMP87CK40AF/CM40AF	350	
Soldering Temperature (time)	Tsld		260 (10 s)	°C
Storage Temperature	Tstg		- 55 to 125	°C
Operating Temperature	Topr		- 30 to 70	°C

Note 1: The absolute maximum ratings are rated values which must not be exceeded during operation, even for an instant. Any one of the ratings must not be exceeded. If any absolute maximum rating is exceeded, a device may break down or its performance may be degraded, causing it to catch fire or explode resulting in injury to the user. Thus, when designing products which include this device, ensure that no absolute maximum rating value will ever be exceeded.

Note 2: \* ; Supply Voltage (V<sub>DD</sub>) & Output Voltage (V<sub>out</sub>) are not compatible with 87PM40A.

Recommended Operating Conditions (V<sub>SS</sub> = 0 V, Topr = - 30 to 70°C)

Parameter	Symbol	Pins	Conditions	Min	Max	Unit	
Supply Voltage	* V <sub>DD</sub>		fc = 8 MHz	NORMAL1, 2 mode	4.5	5.5	V
				IDLE1, 2 mode			
			fc = 4.2 MHz	NORMAL1, 2 mode	2.7		
				IDLE1, 2 mode			
			fs = 32.768 kHz	SLOW mode	2.0		
SLEEP mode							
Input High Voltage	V <sub>IH1</sub>	Except hysteresis input	V <sub>DD</sub> ≥ 4.5 V	V <sub>DD</sub> × 0.70	V <sub>DD</sub>	V	
	V <sub>IH2</sub>	Hysteresis input		V <sub>DD</sub> × 0.75			
	V <sub>IH3</sub>			V <sub>DD</sub> < 4.5 V			V <sub>DD</sub> × 0.90
Input Low Voltage	V <sub>IL1</sub>	Except hysteresis input	V <sub>DD</sub> ≥ 4.5 V	0	V <sub>DD</sub> × 0.30	V	
	V <sub>IL2</sub>	Hysteresis input			V <sub>DD</sub> × 0.25		
	V <sub>IL3</sub>				V <sub>DD</sub> < 4.5 V		V <sub>DD</sub> × 0.10
Clock Frequency	fc	XIN, XOUT	V <sub>DD</sub> = 4.5 to 5.5 V	1.0	8.0	MHz	
			V <sub>DD</sub> = 2.7 to 5.5 V		4.2		
	fs	XTIN, XTOUT		30.0	34.0	kHz	

Note 1: The recommended operating conditions for a device are operating conditions under which it can be guaranteed that the device will operate as specified. If the device is used under operating conditions other than the recommended operating conditions (supply voltage, operating temperature range, specified AC/DC values etc.), malfunction may occur. Thus, when designing products which include this device, ensure that the recommended operating conditions for the device are always adhered to.

Note 2: \* ; Supply Voltage (V<sub>DD</sub>) is not compatible with 87PM40A.

**D.C. Characteristics** ( $V_{SS} = 0\text{ V}$ ,  $T_{opr} = -30\text{ to }70^{\circ}\text{C}$ )

Parameter	Symbol	Pins	Conditions	Min	Typ.	Max	Unit
Hysteresis Voltage	$V_{HS}$	Hysteresis inputs	$V_{DD} = 5.0\text{ V}$	–	0.9	–	V
Input Current	$I_{IN1}$	TEST	$V_{DD} = 5.5\text{ V}$ $V_{IN} = 5.5\text{ V} / 0\text{ V}$	–	–	$\pm 2$	$\mu\text{A}$
	$I_{IN2}$	Open drain ports and tri-state ports					
	$I_{IN3}$	RESET, STOP					
Input Low Current	$I_{IL}$	Push-pull ports	$V_{DD} = 5.5\text{ V}$ , $V_{IN} = 0.4\text{ V}$	–	–	–2	mA
Input Resistance	$R_{IN2}$	RESET		100	220	450	k $\Omega$
Output Leakage Current	$I_{LO}$	Open drain ports	$V_{DD} = 5.5\text{ V}$ , $V_{OUT} = 5.5\text{ V}$	–	–	2	$\mu\text{A}$
		Tri-state ports	$V_{DD} = 5.5\text{ V}$ , $V_{OUT} = 5.5\text{ V} / 0\text{ V}$	–	–	$\pm 2$	
Output High Voltage	$V_{OH1}$	Push-pull ports	$V_{DD} = 4.5\text{ V}$ , $I_{OH} = -200\ \mu\text{A}$	2.4	–	–	V
	$V_{OH2}$	Tri-state ports	$V_{DD} = 4.5\text{ V}$ , $I_{OH} = -0.7\text{ mA}$	4.1	–	–	
Output Low Voltage	$V_{OL}$	Except XOUT and port P3	$V_{DD} = 4.5\text{ V}$ , $I_{OL} = 1.6\text{ mA}$	–	–	0.4	V
Output Low Current	$I_{OL3}$	Port P3	$V_{DD} = 4.5\text{ V}$ , $V_{OL} = 1.0\text{ V}$	–	20	–	mA
Supply Current in NORMAL 1, 2 mode	$I_{DD}$		$V_{DD} = 5.5\text{ V}$ $f_c = 8\text{ MHz}$ $f_s = 32.768\text{ kHz}$ $V_{IN} = 5.3\text{ V} / 0.2\text{ V}$	–	10	16	mA
Supply Current in IDLE 1, 2 mode				–	4.5	6	mA
Supply Current in SLOW mode				–	30	60	$\mu\text{A}$
Supply Current in SLEEP mode				–	15	30	$\mu\text{A}$
Supply Current in STOP mode				–	0.5	10	$\mu\text{A}$

Note 1: Typical values show those at  $T_{opr} = 25^{\circ}\text{C}$ .  
 Note 2: Input Current ; The current through pull-up or pull-down resistor is not included.  
 Note 3:  $I_{DD}$  ; Except for  $I_{REF}$

**A / D Conversion Characteristics** ( $V_{SS} = 0\text{ V}$ ,  $V_{DD} = 2.7\text{ to }5.5\text{ V}$ ,  $T_{opr} = -30\text{ to }70^{\circ}\text{C}$ )

Parameter	Symbol	Conditions	Min	Typ.	Max	Unit
Analog Reference Voltage	$V_{AREF}$	$V_{AREF} - V_{ASS} \geq 2.5\text{ V}$	2.7	–	$V_{DD}$	V
	$V_{ASS}$		$V_{SS}$	–	1.5	
Analog Input Voltage	$V_{AIN}$		$V_{ASS}$	–	$V_{AREF}$	V
Analog Supply Current	$I_{REF}$	$V_{AREF} = 5.5\text{ V}$ , $V_{ASS} = 0.0\text{ V}$	–	0.5	1.0	mA
Nonlinearity Error		$V_{DD} = 5.0\text{ V}$ , $V_{SS} = 0.0\text{ V}$ $V_{AREF} = 5.000\text{ V}$ $V_{ASS} = 0.000\text{ V}$ or $V_{DD} = 2.7\text{ V}$ , $V_{SS} = 0.0\text{ V}$ $V_{AREF} = 2.700\text{ V}$ $V_{ASS} = 0.000\text{ V}$	–	–	$\pm 1$	LSB
Zero Point Error			–	–	$\pm 1$	
Full Scale Error			–	–	$\pm 1$	
Total Error			–	–	$\pm 2$	

Note : Quantizing Error is not contained in Total Errors.

**A.C. Characteristics**

( $V_{SS} = 0\text{ V}$ ,  $V_{DD} = 4.5\text{ to }5.5\text{ V}$ ,  $T_{opr} = -30\text{ to }70^\circ\text{C}$ )

Parameter	Symbol	Conditions	Min	Typ.	Max	Unit
Machine Cycle Time	$t_{cy}$	In NORMAL 1, 2 mode	0.5	-	4	$\mu\text{s}$
		In IDLE 1, 2 mode				
		In SLOW mode	117.6	-	133.3	
		In SLEEP mode				
High Level Clock Pulse Width	$t_{WCH}$	For external clock operation (XIN input), $f_c = 8\text{ MHz}$	50	-	-	ns
Low Level Clock Pulse Width	$t_{WCL}$					
High Level Clock Pulse Width	$t_{WSH}$	For external clock operation (XTIN input), $f_s = 32.768\text{ kHz}$	14.7	-	-	$\mu\text{s}$
Low Level Clock Pulse Width	$t_{WSL}$					

**Recommended Oscillating Condition**

( $V_{SS} = 0\text{ V}$ ,  $V_{DD} = 4.5\text{ to }5.5\text{ V}$ ,  $T_{opr} = -30\text{ to }70^\circ\text{C}$ )

Parameter	Oscillator	Frequency	Recommended Oscillator	Recommended Condition	
				$C_1$	$C_2$
High-frequency	Ceramic Resonator	8 MHz	KYOCERA KBR8.0M	30 pF	30 pF
		4 MHz	KYOCERA KBR4.0MS MURATA CSA4.00MG		
	Crystal Oscillator	8 MHz	TOYOCOM 210B 8.0000	20 pF	20 pF
		4 MHz	TOYOCOM 204B 4.0000		
Low-frequency	Crystal Oscillator	32.768 kHz	NDK MX-38T	15 pF	15 pF

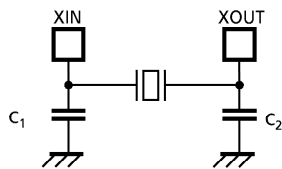

(1) High-frequency

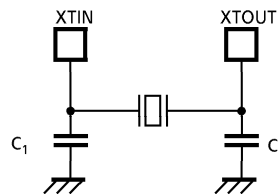

(2) Low-frequency

*Note : An electrical shield by metal shield plate on the surface of the IC package should be recommendable in order to prevent the device from the high electric fieldstress applied from CRT (Cathode Ray Tube) for continuous reliable operation.*